



MESTEK, INC.



Commercial Heat Pump

Inverter Air-to-Water

HP Series 0275

Installation and
Instruction Manual



MESTEK, INC.

260 North Elm Street
Westfield, MA 01085
Phone: (413) 564-5540

7555 Tranmere Drive
Mississauga, Ontario L5S 1L4 Canada
Phone: (905) 670-5888

www.mestek.com

Read Before Proceeding

- In order to provide the customers with high quality, strong reliability and good versatility in a product, this heat pump is produced by strict design and manufacturing standards. This manual includes all the necessary information about installation, troubleshooting, and maintenance.

Please read this manual carefully before you open or maintain the unit. The manufacturer of this product will not be held responsible if someone is injured or the unit is damaged, as a result of improper installation, troubleshooting, unnecessary maintenance which is not described in this manual.

The unit must be installed by a licensed, qualified installer.

- It is vital that the below instructions are adhered to at all times to uphold the warranty.
 - The unit can only be opened or repaired by qualified installer or an authorized dealer.
 - Maintenance and operation must be carried out according to the recommended time and frequency, as stated in this manual.
 - Use genuine standard replacement parts only.

Failure to comply with these recommendations will void the warranty.

- Inverter air-to-water heat pump is high efficient, energy saving and environment friendly, which is mainly used for space heating/cooling and some DHW applications where needed.

Hazard Definitions

The following terms are used throughout this manual to bring attention to the presence of potential hazards or to important information concerning the product.

▲ DANGER Indicates an imminently hazardous situation, which if not avoided, WILL result in death, serious injury or substantial property damage.

▲ WARNING Indicates an imminently hazardous situation, which if not avoided, COULD result in death, serious injury or substantial property damage.

▲ CAUTION Indicates an imminently hazardous situation, which if not avoided, MAY result in minor injury or property damage.

NOTICE Used to notify of special instructions on installation, operation or maintenance, which are important to equipment, but not related to personal injury hazards.

HP General Information

The HP Series air-to-water heat pump provides building owners with an all electric, environmentally friendly alternative to boilers for their low temp heating applications while also being able to reverse cycle and provide hydronic cooling.

The HP Series utilizes advanced EVI (Enhanced Vapor Injection) technology, an intelligent controls system and R410a refrigerant to produce water temperatures up to 140°F in ambient temperatures as low as -20°F. This allows for complete flexibility in most climates while maintaining efficiencies that benefit the end user. The inverter compressor technology provides a precise control of capacities allowing for load matching throughout the range of the product and eliminating wasteful usage of energy in a typical on/off compressor unit.

Low Ambient Temperature Cooling Operation

If cooling operation is desired in a year-round application, or any time outdoor temperatures are expected to be consistently below 55°F, the fan operation should be modified in order to ensure proper operating conditions within the refrigeration system.

Specifications

Choose the Correct Size Heat Pump

Perform appropriate load calculation to determine required heating or cooling load for the project. Refer to specifications in this manual to determine proper size heat pump.

Table 1 Specification Data

HP0275

Heating*	Capacity Range	Btu/hr	101,941-288,226
	Power Input Range	kW	13-28
	Efficiency	COP	Up to 3.04
Heating**	Capacity Range	Btu/hr	66,345-188,981
	Power Input Range	kW	12.85-25.92
	Efficiency	COP	Up to 2.14
Cooling***	Capacity Range	Btu/hr	129,661-203,681
	Power Input Range	kW	8.7-23
	Efficiency	EER	2.5
	IPLV****	EER	17.18
Refrigerant	Type		R410a
	Amount (Qty)	lbs	20 (2)
	Pressure (low)	PSI	305
	Pressure (high)	PSI	638
Dimensions	Shipping (LxWxH)	in	89 x 50 x 89
	Unit (LxWxH)	in	86 x 45 x 84
	Weight	lbs	1615
Electrical	Volts/Ph/hz		460/3/60
	MCA	Amps	60
	MOPD	Amps	70
Hydronic	Pressure Drop (@75GPM)	PSI (ft/hd)	10 (23)
	Connection	In	4
	Min Flow	G.P.M.	44
	Max Flow	G.P.M.	75
	Max System Pressure	PSI	145
	Water Connection	In	4
	Sound @ 3 meters	dB(A)	67
	Operating temps	°F	-20-120

* Heating (DB)@ 47°F, Delivered Water 120°F per AHRI 550-590 (75 GPM) EWT 110°F

** Heating (DB)@ 17°F, Delivered Water 120°F per AHRI 550-590 (75 GPM) EWT 110°F

***Cooling (DB/WB)@ 95°F/86°F, Delivered Water 44°F per AHRI 550/590 (60GPM) EWT 54°F

****IPLV is the recognized measurement of efficiency for Integrated Part Load Values in accordance with AHRI 550/590.

Ambient temp = 95°F. Delivered Water = 44°F (44GPM)

Table 2

Heating

Hz	Water T (°F)	Ambient (°F)	Capacity (btu/hr)	Power (kW)	COP	
90	100	-20	145,242	21.13	2.01	
		-4	173,960	21.31	2.39	
		17	211,215	21.73	2.85	
		47	322,135	23.28	4.05	
	120	-20	129,954	25.21	1.51	
		-4	155,648	25.42	1.79	
		17	188,981	25.92	2.14	
		47	288,226	27.77	3.04	
	140	-20				
		-4	137,337	28.79	1.4	
		17	166,748	29.36	1.66	
		47	254,317	31.46	2.37	
60	100	-20	98,888	21.13	1.67	
		-4	118,441	21.31	1.98	
		17	143,806	21.73	2.42	
		47	213,626	23.28	3.65	
	120	-20	88,479	25.21	1.25	
		-4	105,973	25.42	1.48	
		17	128,668	25.92	1.82	
		47	191,139	27.77	2.74	
	140	-20				
		-4	93,506	28.79	1.16	
		17	113,531	29.36	1.41	
		47	168,652	31.46	2.13	
30	100	-20	47,899	10.57	1.33	
		-4	57,370	10.75	1.56	
		17	74,150	10.64	2.04	
		47	113,934	10.59	3.15	
	120	-20	42,857	12.61	1	
		-4	51,331	12.82	1.56	
		17	66,345	12.85	2.04	
		47	101,941	12.99	3.15	
	140	-20				
		-4	45,292	14.52	0.91	
		17	58,539	14.38	1.19	
		47	89,948	14.31	1.84	

Specifications

Figure 1 Dimensions

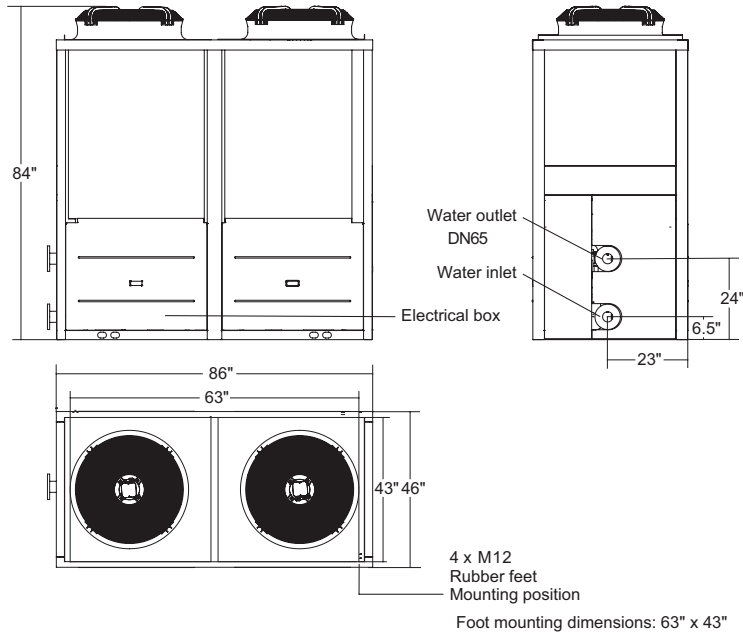

Installation

Transporting

During transportation, be sure that the unit is always standing up. The unit shall not be laid on its side. Failure to keep upright can damage components and void the product warranty.

If the unit needs to be lifted by crane, please use cable appropriate for the weight of the unit and lifting points located at the bottom of the unit. Ensure the heat pump is protected using protective material between the cables and the unit. This will prevent any damage to the coil, fans and cabinet. (see figure for example)

Figure 2

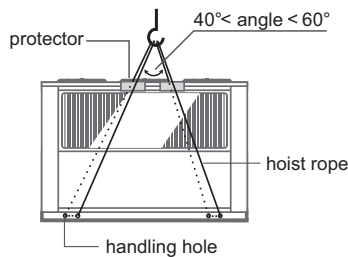

Installation Location

- Units can be installed outdoors as long as the location determined can handle the weight (see specifications) for each unit.
- The location is free from heat radiation and other possible fire hazards.
- There must be enough space around the unit for maintenance see "Required Clearances". The base of the unit must be located a minimum of 10 inches off the ground or above the highest anticipated snow level to allow proper condensate drainage. The condensate shall be provided a path to drain before re-freezing in an area that could create an obstruction or hazardous conditions such as on a walkway.

⚠ WARNING Heat exchanger fins are sharp and can cut a finger if handled improperly. Please handle with gloves or protective wear.

Installation

Figure 3 Required Clearances (in)

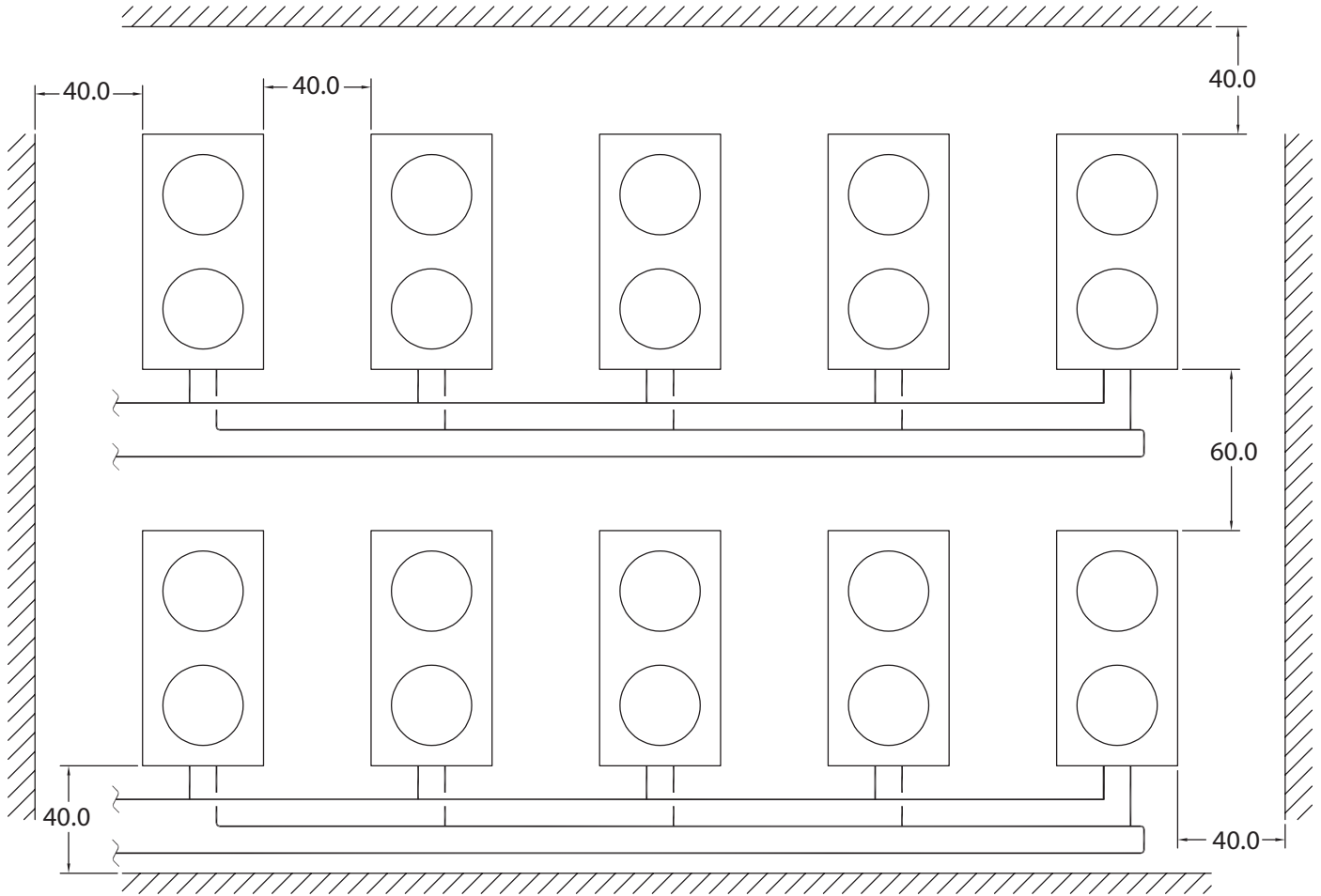
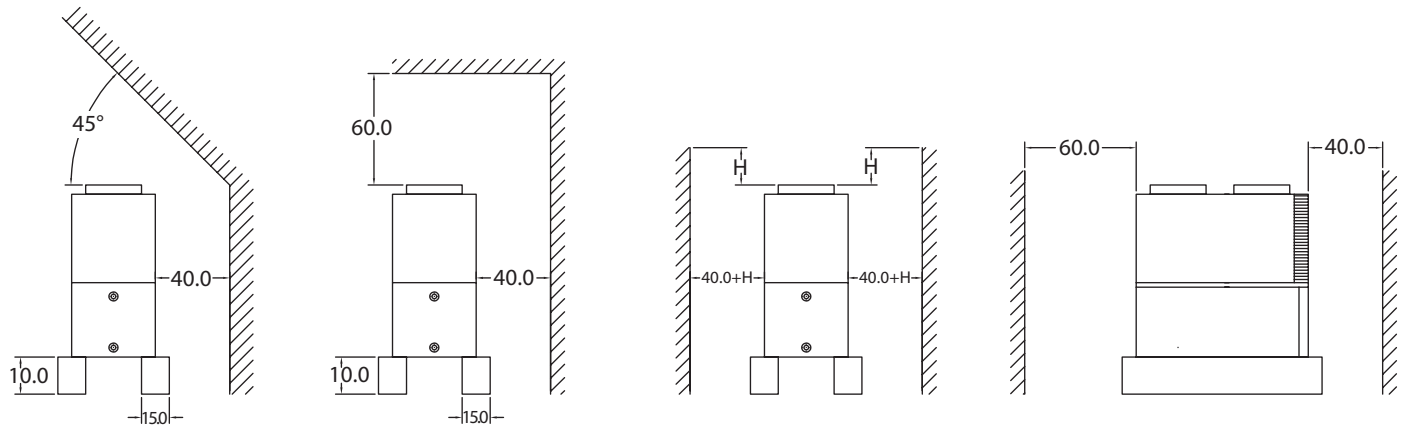

Figure 4



Installation

Prior to Initial Startup

⚠ WARNING Before proceeding read and fully understand the instructions contained in this manual. Do not attempt to operate this heat pump if it has not been installed in accordance with the guidelines set forth in this manual. Failure to comply with this warning can result in extensive property damage, severe personal injury or death! Failure to comply can also void product warranty.

Inspection before turning unit on;

- Check and make sure that the pipe connections are secured, leak free and the appropriate valves are open.

- Check the water loop to ensure there is sufficient water inside the expansion tank, the water loop is full of water/glycol mix* and without any air. Also make sure there is good insulation for the piping.
- Check all electrical wiring. Make sure that the power voltage is normal, the wiring is completed per the diagram, and the ground is connected.
- Ensure air-to-water heat pumps are free of any debris and that all loose screws or parts have been secured. Once power is turned on, check controller display for any immediate faults. A licensed and qualified installer can also verify refrigerant pressures by using the refrigerant ports located within the unit.
- The flow switch is installed inside of the heat pump. Check to ensure that the wiring and action of the switch is normal and controlled by the controller. Flow switch will open at 27 G.P.M.

Glycol/Water System

Table 3 Glycol Concentrations (10% Minimum, 50% Maximum)

Propylene Glycol %	10	20	30	40	50
Min. Ambient Temp for Operation	26°F/-3°C	18°F/-8°C	8°F/-13°C	-7°F/-22°C	-29°F/-34°C
Capacity Multiplier	0.99	0.98	0.96	0.93	0.88
Pressure Drop Multiplier (Cooling)	1.10	1.20	1.34	1.5	1.65
Pressure Drop Multiplier (Heating)	1.10	1.20	1.34	1.46	1.5
Minimum Expansion Volume / System Volume					
Heating and Cooling	1 gallon expansion per 15 gallons system volume				
Heating only, HP only	1 gallon expansion per 20 gallons system volume				
Heating only, with Boiler	1 gallon expansion per 15 gallons system volume				

Glycol / Water Mixture

⚠ WARNING The water system must contain a mixture of inhibited glycol and water with thermal protection sufficient for the coldest expected temperature for the installation. The inhibitor level can degrade over time, and may need to be adjusted periodically. The inhibitor is essential to prevent the glycol from accelerating corrosion of metal components in the system. The glycol and inhibitor levels must be checked regularly (no less than once annually).

⚠ CAUTION The minimum allowable concentration of glycol is 10% by volume in all installations.

⚠ CAUTION Automotive glycol is not suitable for use in the system. Over time it may leave deposits which will degrade the performance and damage pumps or other devices in the system. Use only propylene glycol mixtures specifically labeled for boiler or HVAC use.

Obtain all components required for installation (piping, pumping etc...) and make sure all components and piping comply with applicable local codes. System fluid expansion must be calculated per established engineering methods.

DO NOT use galvanized pipe anywhere in the system. Galvanizing will react with the glycol and can cause glycol degradation and sludge in the system.

Insulate The Piping

1. After testing and draining the system, apply pipe insulation. Fill system with glycol/water mixture. Calculate the system volume.
2. See Table 3, for required glycol concentration for the minimum expected outside temperature.
3. Obtain the required volume inhibited glycol/water solution premixed or mix in a clean container. (The glycol must contain an inhibitor to prevent metal corrosion.)
4. Pump the glycol/water solution into the system, allowing air to escape through the purge valve(s).
5. After filling the system, sample the system fluid and verify glycol and inhibitor percentages, following instructions provided with the glycol.



General Piping Requirements

CAUTION Improper piping of this heat pump will void the manufacturer's warranty and can cause system failure resulting in flooding and extensive property damage!

NOTICE Shut off valves and unions should be installed at the inlet and outlet connections of the heat pump to provide for isolation of the unit should servicing be necessary.

Freeze Protection

Installations in areas where the danger of freezing exists are not recommended unless proper freeze protection is provided. The following precautions **MUST** be observed:

1. A continuous flow of water through the unit **MUST** be maintained! The pump responsible for flow through the heat pump must run continuously!
2. A polypropylene glycol/water mixture suitable for the minimum temperature that the unit will be exposed to must be used. The pump must be capable of producing a minimum of 15% more flow and overcoming a 20% increase in head loss. Please refer to glycol/water system of this manual for performance correction factors and suggested glycol percentages for the heat pump system.
3. If the unit must be shut off for any reason the electric and water supplies **MUST** be shut off and the unit and its pump completely drained.

System Piping

General Piping Requirements

All system piping must be installed by a qualified technician in accordance with the latest revision of the ANSI/ASME Boiler and Pressure Vessel Code, Section IV.

All applicable local codes and ordinances must also be followed. A minimum clearance of **1 in, 25 mm** must be maintained between system pipes and all combustible construction. All system piping must be supported by suitable hangers, not the heat pump. The thermal expansion of the system must be considered when supporting the system. A minimum system pressure of **20 psig, 138 kPa** must be maintained at heat pump operating conditions. For glycol systems, a minimum system pressure of **30 psig, 207 kPa** must be maintained at system operating conditions.

CAUTION **System Cleaning & Flushing:** Prior to commissioning the heat pump, the piping/system must be cleaned and flushed to prevent contaminants from settling back into the heat pump and fouling the heat exchanger.

Isolate the heat pump from the system prior to the cleaning process. Fill the system with water, add the cleaning solution and follow the solution manufacturer's instructions. Once clean, refill the system with clean water as specified in the Water Treatment section.

Water Treatment

This heat pump was designed to operate in a closed loop heating system. System fill water must not contain more than 500 ppm of total dissolved solids, less than 150 ppm chloride concentration and no greater than 300 ppm hardness. Suspended solids such as Magnetite, Iron Oxides must be flushed from the system prior to commissioning the heat pump(s). The PH level must be within the 6.5-10 range. Where required, the system must be protected by the addition of a corrosion inhibitor per the chemical supplier's instructions.

For systems requiring glycol for freeze protection use a glycol/water mix that prevents foaming. Air entrapped within foam significantly decreases heat transfer and can result in damage to the heat exchanger. Products such as DOWFROST, DOWTHERM, UCARTHERM or an equivalent product must be used to ensure proper protection to the heat pump.

The water used for dilution of concentrated heat transfer fluids must be distilled, de-ionized, or equivalently clean as stated above. De-ionized water by itself can be aggressive towards many metals, but is perfectly safe when used for dilution of DOWFROST, DOWTHERM or UCARTHERM as specified by the manufacturer.

FAILURE TO ENSURE PROPER WATER QUALITY CAN RESULT IN DAMAGE TO THE HEAT PUMP(S) VOIDING THE WARRANTY.

Water Meter

Make-up water introduced into a closed system due to system leaks can negatively affect the long term reliability of the heating system resulting in abnormal heat pump water quality. It is recommended that a water meter be installed in the system make-up line. If make-up is recorded, the leaks must be found and repaired.

Pump Requirements

This heat pump requires a continuous minimum water flow for proper operation. The system pump must be sized to overcome the head loss of the heat pump and the system in order to achieve the required temperature rise. If the system contains hydronic antifreeze this must be considered when sizing the pump.

Expansion Tank & Air Separator

An expansion tank or other means to control thermal expansion must be installed in the system. An expansion tank must be installed close to the heat pump on the suction side of the pump. An air scoop and automatic air vent must also be installed to eliminate air trapped in the system.

Reverse Return Piping (RECOMMENDED)

Systems using multiple heat pumps can also be installed using a reverse return system, see piping schematics in this manual.

Primary/Secondary Piping

Although acceptable, the system is not as cost effective as reverse return piping. Piping schematics in this manual shows a typical primary/secondary piping system. A dedicated pump is used to maintain a constant water flow through the heat pump. Flow must be properly accounted for in the design of primary/secondary systems. In order to prevent heat pump(s) short cycling the system flow must be equal to or higher than the heat pump(s) local flow. Systems using multiple heat pumps can be installed using a primary/secondary manifold system, see piping schematics in this manual.

Figure 5 Single Heat Pump Piping

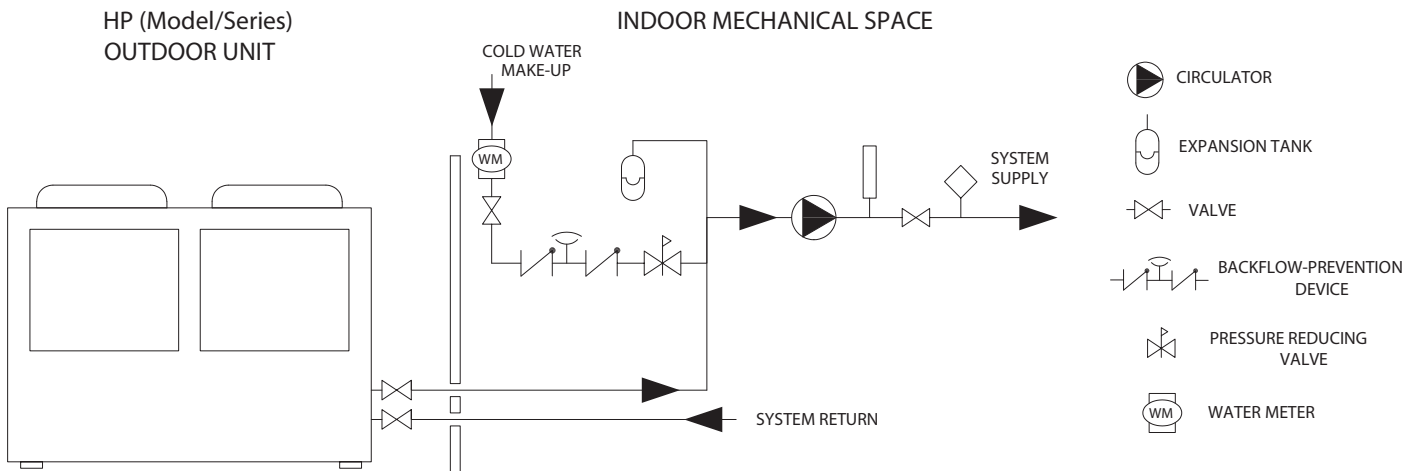
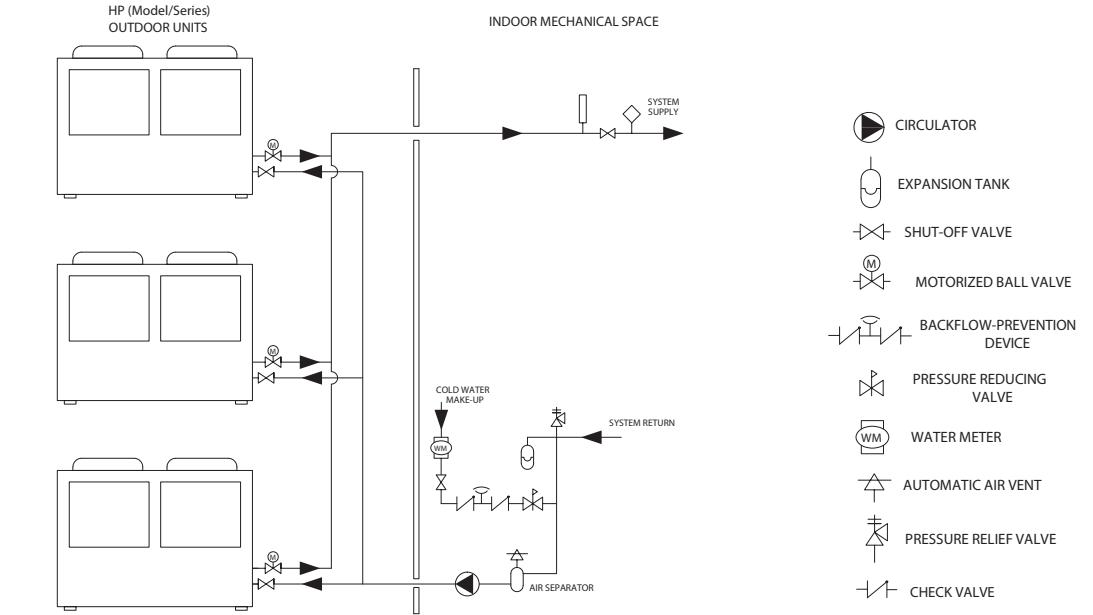
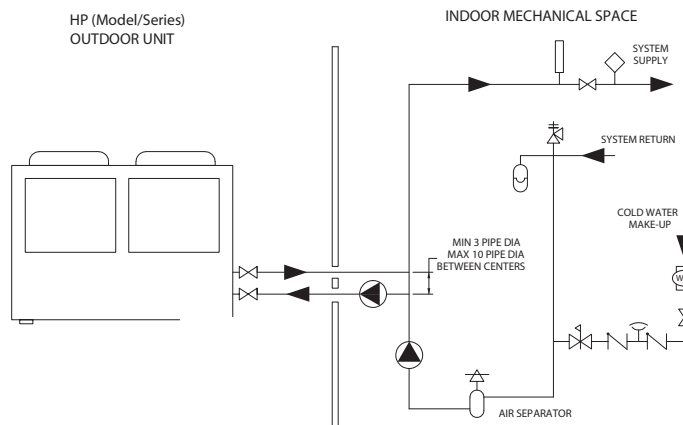

Figure 6 Typical Multiple Heat Pump Reverse Return Piping (RECOMMENDED)



NOTE: Not all system valves may be shown. Consult local codes for additional system components which may be necessary.

Figure 7 Typical Single Heat Pump Primary/Secondary Piping



NOTE: Not all system valves may be shown. Consult local codes for additional system components which may be necessary.

Figure 8 Typical Multiple Heat Pump Primary/Secondary Piping

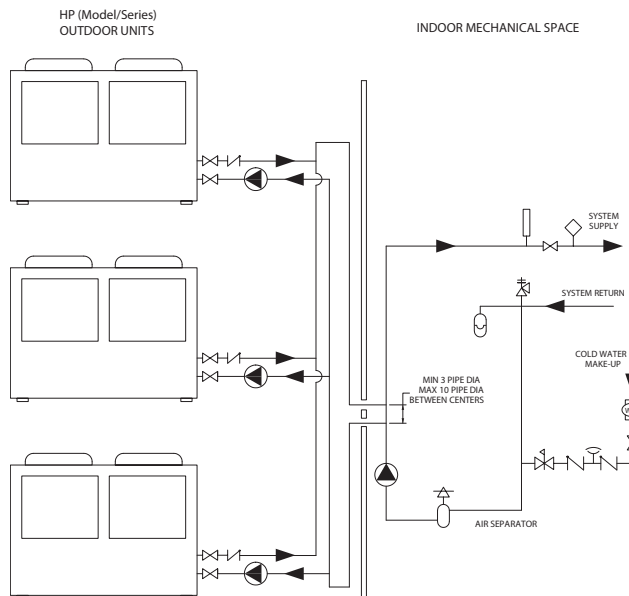

NOTE: Not all system valves may be shown. Consult local codes for additional system components which may be necessary.

Electrical Wiring and Controls

Electrical Connections

- The power supply must go through the wire access and be connected to the power supply terminals in the control box. Then connect the 3-signal wire plugs of the wire controller and main controller.
- External pump can be powered through main power terminals accessed through main power access on side of the units.
- If an additional auxiliary heater is need to be controlled by the heat pump controller, the relay (or power) of the aux-heater must be connected to the relevant output of the controller.
- Power supply for the unit should follow unit electrical specifications and adhere to local and national electrical codes.

Electrical Power Connections

CAUTION Label all wires prior to disconnection when servicing controls. Wiring errors can cause improper and dangerous operation! Verify proper operation after servicing.

The electrical connections to this heat pump must be made in accordance with all applicable local codes and the latest revision of the National Electrical Code, ANSI /NFPA-70. Installation should also conform with CSA C22.1 Canadian Electrical Code Part I if installed in Canada. A separate circuit breaker must be installed for the heat pump - (if required, the optional local pump FLA must be incorporated and sized accordingly). A properly rated shut-off switch should be located at the heat pump. The heat pump must be grounded in accordance with the authority having jurisdiction, or if none, the latest revision of the National Electrical Code, ANSI/NFPA-70.

The electrical loads given in the Specification Table, allow for a pump load of no more than 5 amps at 110 VAC (2.5 amps at 230 VAC). If the pump load exceeds this, provide a separate power source to the pump.

Line voltage field wiring of any controls or other devices must use copper conductors with a minimum size of #14 awg.

Refer to point of connection diagram in this manual and the wiring diagram supplied with the heat pump for proper wiring connections.

Figure 9 Wiring Diagram

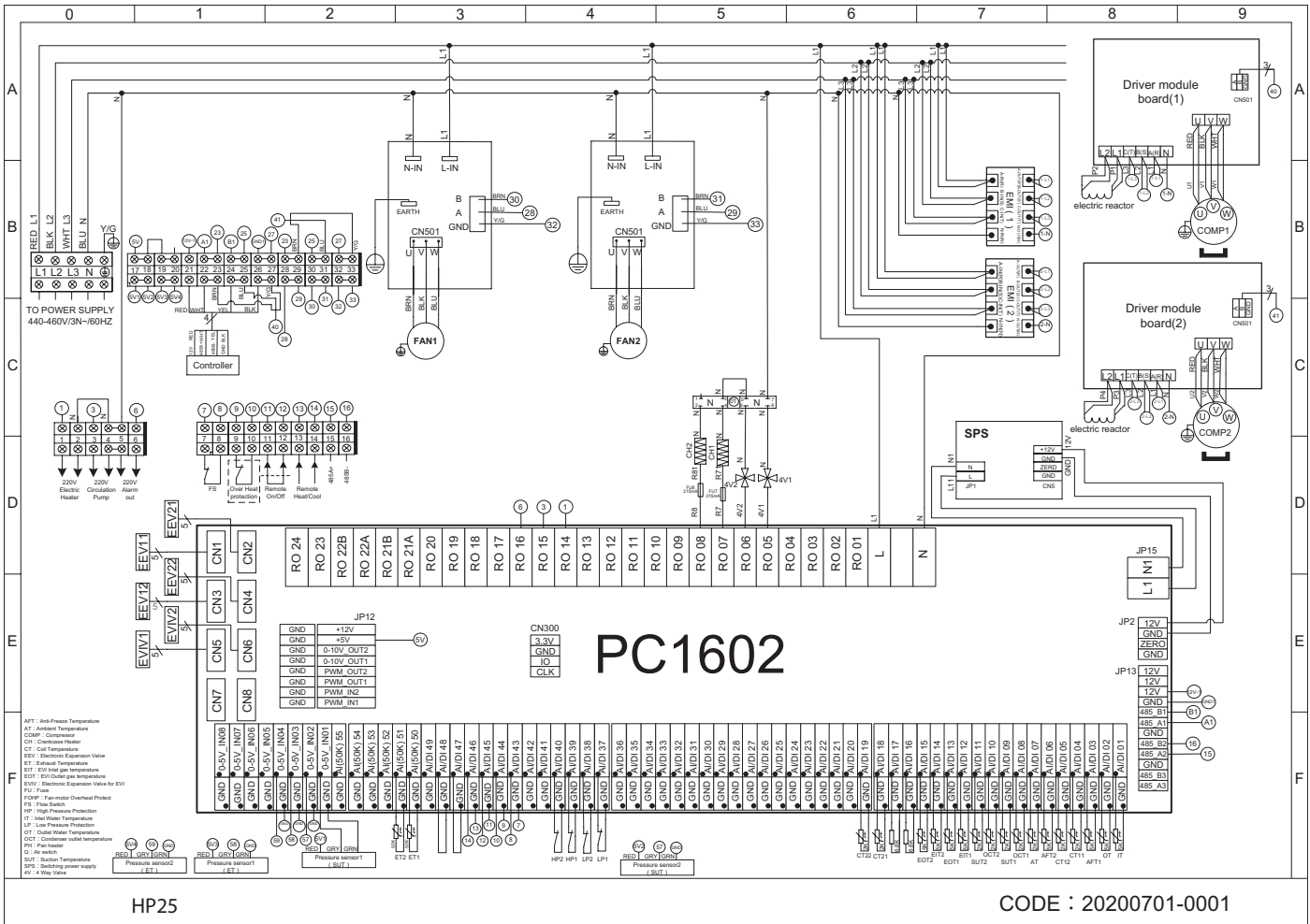

Electrical Wiring and Controls

Figure 10 Controller Interface Diagram and Definition

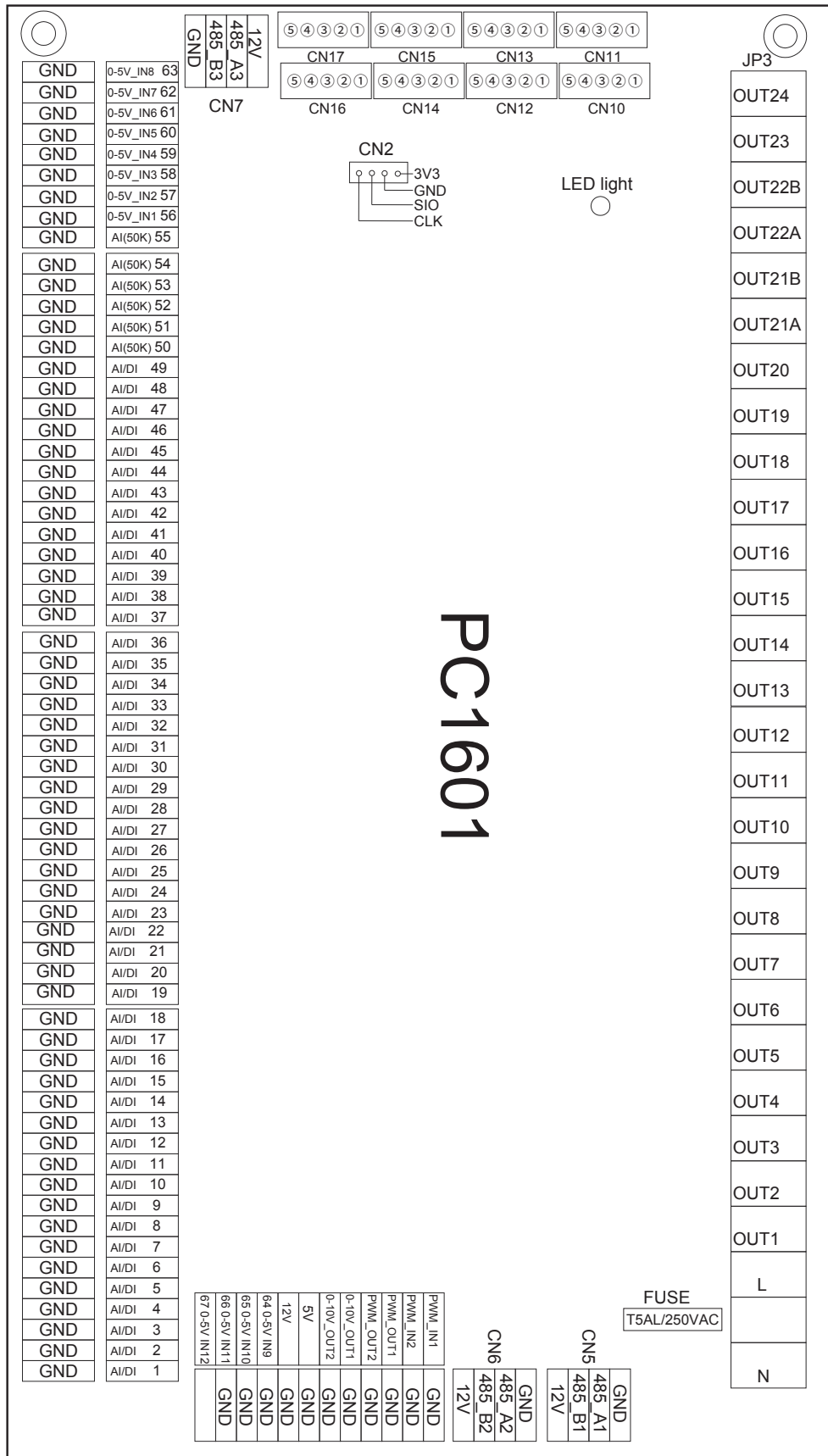

Table 4 The Input and Output Interface Instructions

No.	Sign	Meaning	No.	Sign	Meaning
1	AI/DI1	Water inlet temperature	29	AI/DI29	No use
2	AI/DI2	Water outlet temperature	30	AI/DI30	No use
3	AI/DI3	System 1 antifreeze temperature	31	AI/DI31	No use
4	AI/DI4	System 1 coil temperature 1	32	AI/DI31	No use
5	AI/DI5	System 1 coil temperature 2	33	AI/DI33	No use
6	AI/DI6	System 2 antifreeze temperature	34	AI/DI34	No use
7	AI/DI7	Ambient temperature	35	AI/DI35	No use
8	AI/DI8	System 1 coil outlet temperature	36	AI/DI36	No use
9	AI/DI9	System 1 return air temperature	37	AI/DI37	System 1 low pressure switch
10	AI/DI10	System 2 coil outlet temperature	38	AI/DI38	System 2 low pressure switch
11	AI/DI11	System 2 return air temperature	39	AI/DI39	System 1 high pressure switch
12	AI/DI12	System 1 EVI inlet temperature	40	AI/DI40	System 2 high pressure switch
13	AI/DI13	System 1 EVI outlet temperature	41	AI/DI41	No use
14	AI/DI14	System 2 EVI inlet temperature	42	AI/DI42	No use
15	AI/DI15	System 2 EVI outlet temperature	43	AI/DI43	Water flow switch
16	AI/DI16	Water tank temperature	44	AI/DI44	Electric heating overload protection switch
17	AI/DI17	End return water temperature	45	AI/DI45	Emergency switch
18	AI/DI18	System 2 coil temperature 1	46	AI/DI46	Mode switch
19	AI/DI19	System 2 coil temperature 2	47	AI/DI47	Fan 1 overload protection switch
20	AI/DI20	No use	48	AI/DI48	Fan 2 overload protection switch
21	AI/DI21	No use	49	AI/DI49	Reserved
22	AI/DI22	No use	50	AI 50(50K)	System 1 exhaust temperature
23	AI/DI23	No use	51	AI 51(50K)	System 2 exhaust temperature
24	AI/DI24	No use	52	AI 52(50K)	No use
25	AI/DI25	No use	53	AI 53(50K)	No use
26	AI/DI26	No use	54	AI 54(50K)	No use
27	AI/DI27	No use	55	AI 55(50K)	No use
28	AI/DI28	No use	56	0-5V_IN1	System 1 low pressure sensor



Table 4 The Input and Output Interface Instructions

No.	Sign	Meaning	No.	Sign	Meaning
57	AI/0-5V_IN2	System 2 low pressure sensor	86	CN17	No use
58	0-5V_IN3	System 1 high pressure sensor	87	OUT1	System 1 fan output (low speed)
59	0-5V_IN4	System 2 high pressure sensor	88	OUT2	System 1 fan output (high speed)
60	0-5V_IN5	No use	89	OUT3	System 2 fan output (low speed)
61	0-5V_IN6	No use	90	OUT4	System 2 fan output (high speed)
62	0-5V_IN7	No use	91	OUT5	System 1 four-way valve output
63	0-5V_IN8	No use	92	OUT6	System 2 four-way valve output
64	0-5V_IN9	No use	93	OUT7	System 1 crankshaft heating belt output
65	0-5V_IN10	No use	94	OUT8	System 2 crankshaft heating belt output
66	0-5V_IN11	No use	95	OUT9	System 1 spray valve output (No use)
67	0-5V_IN12	No use	96	OUT10	System 2 spray valve output (No use)
68	PWM_IN1	Flow meter	97	OUT11	Water replenishing valve (reserved)
69	PWM_IN2	No use	98	OUT12	Backwater valve (reserved)
70	PWM_OUT1	No use	99	OUT13	Water supply pump (reserved)
71	PWM_OUT2	No use	100	OUT14	Electric heating
72	0-10V_OUT1	No use	101	OUT15	Circulating water pump output
73	0-10V_OUT2	No use	102	OUT16	Alarm output
74	+5V	No use	103	OUT17	System 1 fan output (high speed)
75	+12V	12V output	104	OUT18	System 2 fan output (high speed)
76	CN5	Wire controlled color display	105	OUT19	No use
77	CN6	Centrally controlled color display	106	OUT20	No use
78	CN7	DTU module	107	OUT21A	No use
79	CN10	System 1 electronic expansion valve (big)	108	OUT21B	No use
80	CN11	System 2 electronic expansion valve (big)	109	OUT22A	No use
81	CN12	System 1 electronic expansion valve (small)	110	OUT22B	No use
82	CN13	System 2 electronic expansion valve (small)	111	OUT23	No use
83	CN14	System 1 EVI electronic expansion valve	112	OUT24	No use
84	CN15	System 2 EVI electronic expansion valve			
85	CN16	No use			

Controls and Operation

Every heat pump is shipped with a wired touch screen controller. The controller should be mounted in an area safe from debris or potential for damage and mounted securely.

Startup Screen

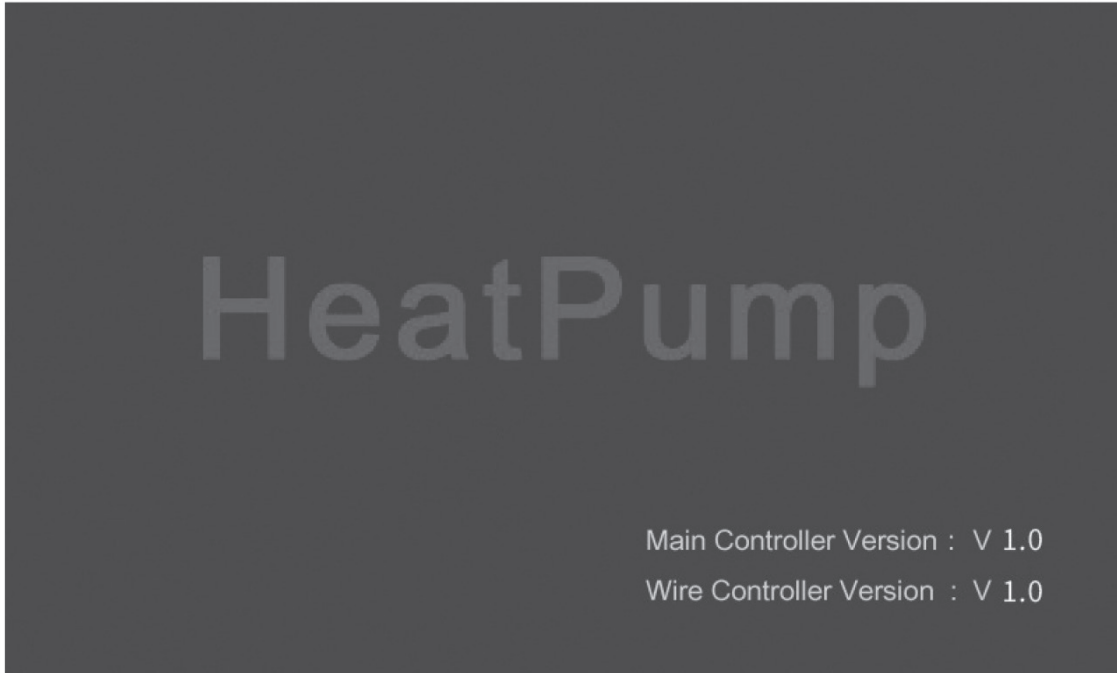

Home Screen in "Off" Mode

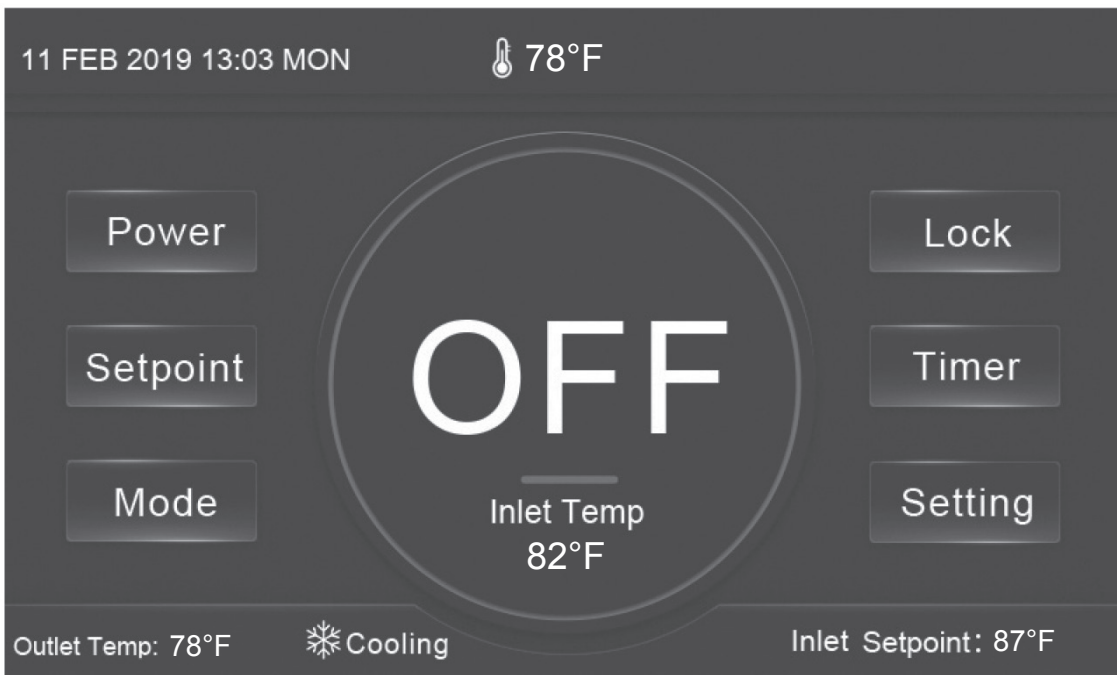

Controls and Operation

Home Screen in "On" Mode

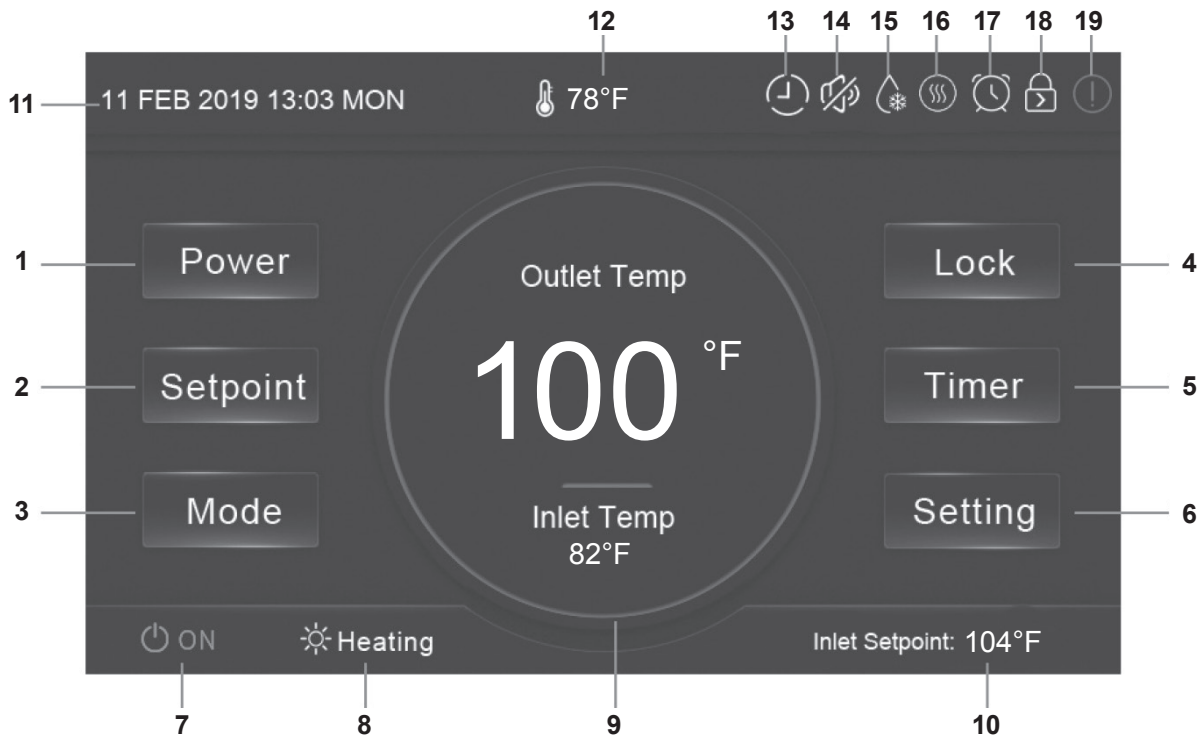





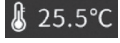









Table 5 Button Function

No.	Name	Description
1	Power	Press to switch ON or OFF
2	Setpoint	Press to set the target temperature
3	Mode	Press to select cooling or heating mode
4	Lock	Press to lock or unlock screen password is "22" to unlock
5	Timer	Press to enter timer setting interface (Temp Timer, Power Timer, Mute Timer)
6	Setting	Press to enter function setting interface (Status, Parameter, Failure, Time)

Controls and Operation

Table 6 Running Status Icons Description

No.	Icon	Description
7		Indicating that the unit is power-on
8	 	Indicating the operating mode: Heating or Cooling
9	Display circle	Indicating the operating status: blue--cooling mode; red-heating mode; grey-power-off mode.
10		Indicating the target temperature of inlet water
11		Indicating the date and time
12		Indicating the ambient temperature
13		Indicating the Temp Timer function is activated
14		Indicating that the mute mode is activated
15		Indicating that the defrost mode is activated
16		Indicating that the electric auxiliary heating mode is activated
17		Indicating that the power timer mode is activated
18		Indicating the lock screen status
19		Fault icon indicating a fault has occurred. Fault icon will blink during a fault and be removed when the fault is cleared.

Controls and Operation

Timer Functions

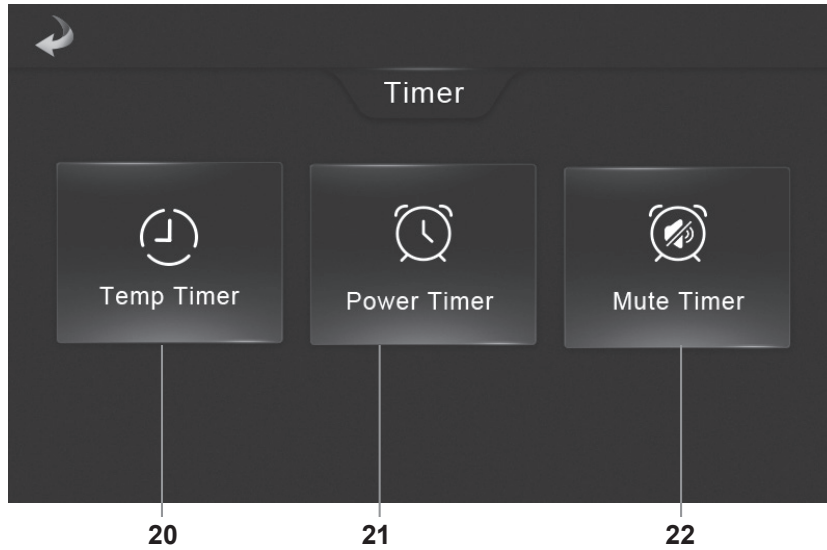

Button Function

No.	Name	Function
20	Temp Timer	Press to enter temp timer settings. Here you can set the schedule and timer based on specific building requirements.
21	Power Timer	Press to enter power timer screen. Here you can set timers to shut the unit down or turn the unit on with timers
22	Mute Timer	Press to enter the mute timer screen. This allows the unit to ignore/override the timer settings.

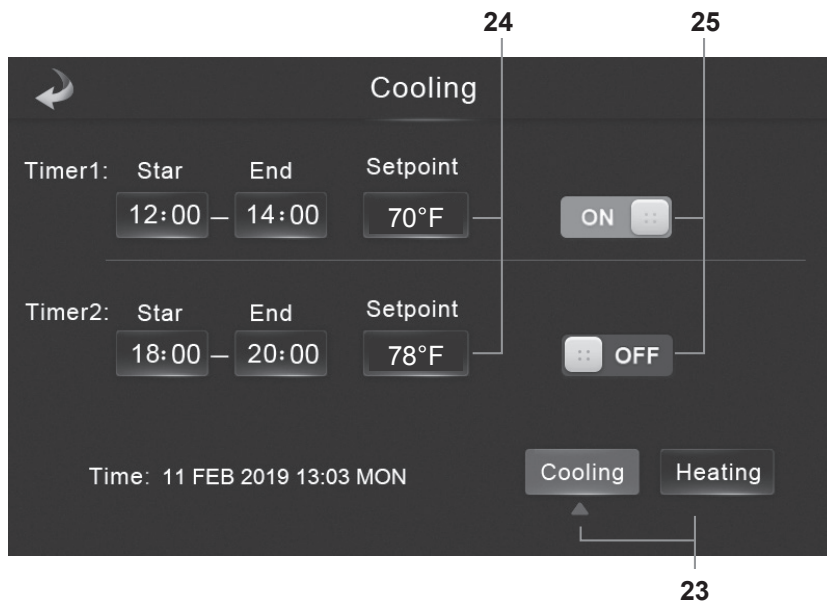

Controls and Operation

The temp timer function allows timers to be set for on or off peak based on each application. First access the temp timer menu (20). Press the cooling or heating (23) to set the mode required, then enter the start/end and setpoints (24). Last press on or off (25) to enable or disable these timers.

Note: green: enable; grey: not enabled.

Power Timer

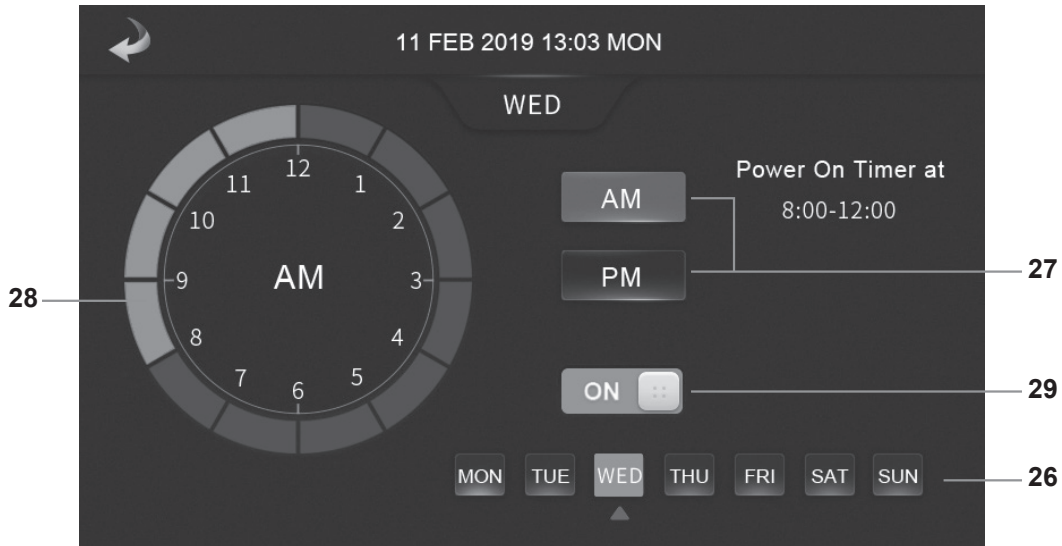

The power timer feature allows the user to set daily time parameters for the unit. To navigate to the power timer screen press power timer (20). Select the specific day of the week (26), time (28) and AM or PM (27). Once finalized turn on or off (29) to enable or disable.

Note: green: enable; grey: not enable.

Controls and Operation

Mute Timer

The mute timer function allows the user to disable/override any timers that are in place. Once selected the screen will display this symbol. 

Settings

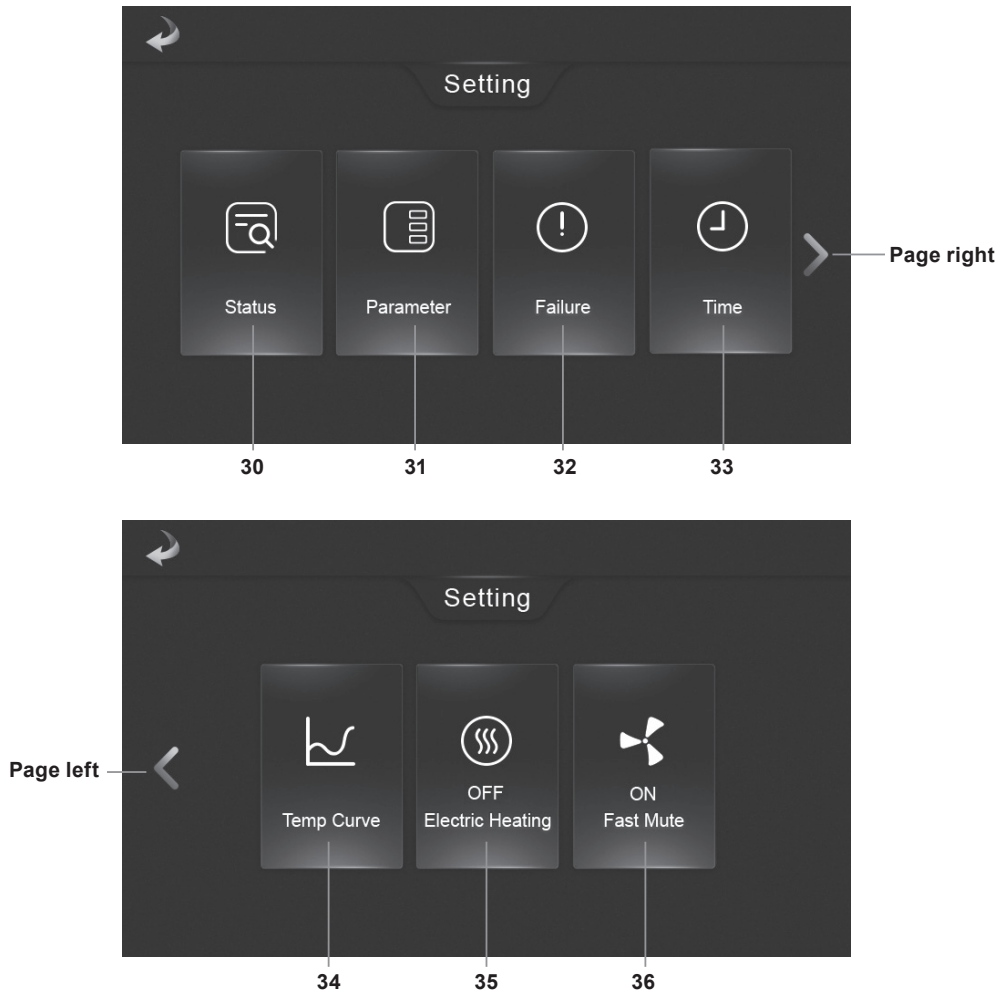

Table 7 Button Description (see below for details on each)

No.	Name	Function
30	Status	Press to enter status menu.
31	Parameter	Press and enter "22" to view/change installer accessible parameters
32	Fault	Press to see current faults or history of faults
33	Time	Press to set time and date of unit.
34	Temp Curve	Press to see recent water temps and curves
35	Electric Heating	Enable or disable ability to power electric heater
36	Fast Mute	Enable or disable fast mute

Controls and Operation

Running Status	
Power	ON
Mode	Cooling
Outlet Water Temp	120°F
Inlet Water Temp	116°F
Ambient Temp	86°F
Running Day(s)	135

Load				
Load	Switch	Temp	Unit Info	Inverter
O01	Syst1: Comp.	ON		
O02	Syst2: Comp.	ON		
O03	Syst1: Fan	OFF		
O04	Syst2: Fan	OFF		
O05	Circulating Pump	ON		1/4
O06	Syst1:4-Way Valve	OFF		

Status Button

By pressing the "status" button the installer will be able to view the current running status of the unit and the status of many of the units components and functions.

Running Status button shows current power mode (on/off) of the unit, outlet and inlet water temperature and ambient temperature.

The unit status button allows access to specific menus involved with the status of the unit. The installer password is '22'. The top/sub menus are "Load" "Switch" "Temp" "Unit Info" "Inverter".

Load

This menu allows access to the current status of compressors, fans, circ pump, 4-way valves electric heater, crankshaft heaters, spray valves, fault alarms, chassis heater, EEV valve steps, and capacity demands.

Switch

This menu allows access to the the current status of the high and low pressure switches (each system), water flow switch, emergency input switch, if the mode switch is open or closed, electric heater overload switch, and each fan protection overload switches.

Temp

This menu allows access to the current status of the following temperature readings:

- Inlet Water
- Outlet Water
- Sys1 & 2 Antifreeze
- Ambient Temp
- Sys1 & 2 coil outlet temp
- Sys 1 & 2 Suction temp
- Sys 1 & 2 coil temps (1 & 2 temperatures)
- Sys 1& 2 evap temp
- Sys 1 & 2 superheat
- Sys 1& 2 EVI (in temp)
- Sys 1 & 2 EVI (out temp)
- Sys 1 & 2 Exhaust temp
- Sys 1 & 2 condensate temp
- Sys 1 & 2 high and low pressure temp
- Current running water flow (m3/hr)

Unit Info

This menu allows access to the specific details to that units software code, and software version for the main board, wired controller, and each inverter boards.

Inverter

This menu allows access to the current status of the following items related to the compressor and fan inverter boards.

- Sys 1 & 2 Compressor set frequency
- Sys 1 & 2 Compressor running frequency
- System 1 & 2 Inverter phase current
- Sys 1 & 2 Inverter board temp
- Sys 1 & 2 Inverter bus voltage
- Sys 1 & 2 If one or two inverter boards are running.
- Sys 1 & 2 If there is a fault on either inverter board
- Sys 1 & 2 Fan set speed
- Sys 1 & 2 Fan running speed
- Sys 1 & 2 Fan phase current
- Sys 1 & 2 Fan IPM temp
- Sys 1 & 2 Fan bus voltage
- Sys 1 & 2 Fan faults

Controls and Operation

Parameter Button

Pressing the “Parameter” button allows installers to access/adjust certain parameters. Refer to the parameter chart for all accessible parameters and limitations.

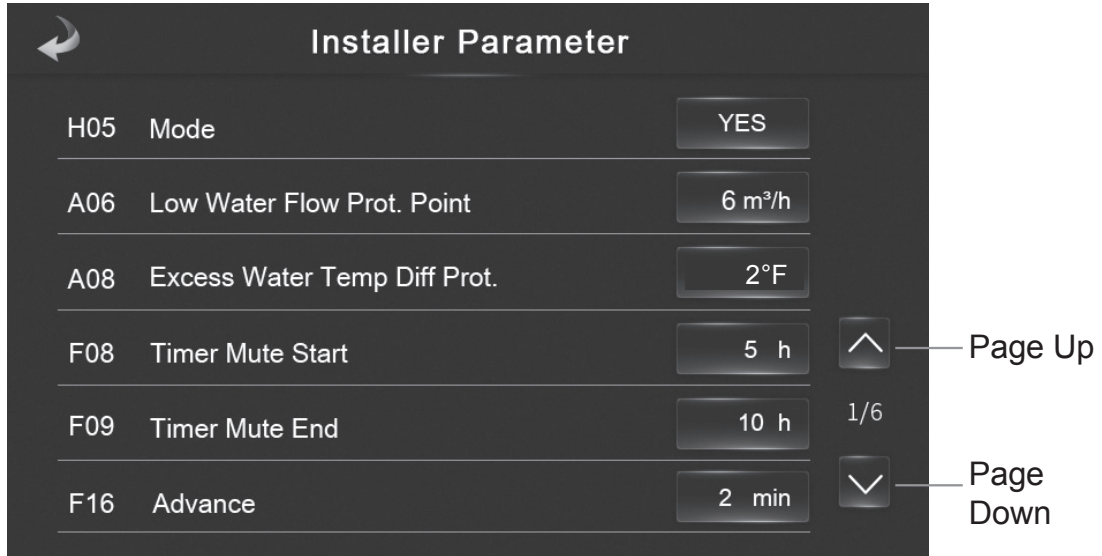

Table 8 Parameter List

Code	Parameter	Range
H	System	
H01	Power Down Memory	0-[No]/1-[Yes]
H02	Syst. Qty	1-[1 Syst.]/2-[2 Syst.]
H03	4-Way Valve Polarity	0-[On-heating]/1-[Off-heating]
H05	Mode	0-[Cool]/1-[Heat&Cool]/2-[Heat]
H06	Model	1-[Polaris]/4-[Module]
H07	Offline Control	0-[Wire] /1-[Mechanical]
H09	Mute	0-[No]/1-[Yes]
H10	Unit Address	1~32
H25	4-Way Valve Delay Comp. Switching Time	0~60s
H27	Comp. Model	1~10
H28	Water Temp Control (Inlet/Outlet)	0-[Inlet]/1-[Outlet]
H29	Comp. Slient Max Running Frequency	0~150Hz
H30	Temperature Unit	0-[°C]/1-[°F]
A	Protection	
A01	Comp. Stop Working Min AT	-38.0~10.0°C (-36.4-50°F)
A02	Water(Out) Antifreezing Prot. Point	-15.0~10.0°C (5-50°F)
A03	Exhaust Air Temp Prot. Point	60.0~130.0°C (140-266°F)
A04	Refrigerant	0-[R410A]/1-[R22]/2-[R134a]/3-[R407C]
A05	Pressure Sensor	0-[No]/1-[Yes]
A06	Low Water Flow Prot. Point	0~50m³/h
A07	Water(Out) High Temp Prot. Point	40~65°C (104-149°F)
A08	Excess Water Temp Diff Prot.	0~25°C (32-77°F)
A09	Refrigerant Leakage Pressure Setpoint	0~5bar

Controls and Operation

Parameter List

Code	Parameter	Range
F	Fan motor	
F01	Speed	0-[1 Speed]/1-[2 Speed]/2-[AC]/3-[DC]
F02	Cooling High Speed Pressure	0~50bar
	Cooling High Speed Coil Temp	-15.0~60.0°C (5-140°F)
F03	Cooling Low Speed Pressure	0~50bar
	Cooling Low Speed Coil Temp	-15.0~60.0°C (5-140°F)
F04	Cooling Motor Off Pressure	0~50bar
	Stop Cool Coil Temp	-15.0~60.0°C (5-140°F)
F05	Heating: High Speed Pressure	0~30bar
	Heating: High Speed Coil Temp	-15.0~60.0°C (5-140°F)
F06	Heating: Low Speed Pressure	0~30bar
	Heating: Low Speed Coil Temp	-15.0~60.0°C (5-140°F)
F07	Heating: Motor Off Pressure	0~30bar
	Stop Heat Coil Temp	-15.0~60.0°C (5-140°F)
F08	Timer Mute Start	0~23h
F09	Timer Mute End	0~23h
F10	Quantity	0-[1 Fan]/1-[2 Fans]
F11	Speed Control	0-[Coil]/1-[Pressure]
F15	Unloading Coil Pressure	0~15bar
	Unloading Coil AT	20~80°C (68-176°F)
F16	Advance	0~120min
F17	DC Fan Motor Max Speed	300~1300r
	AC Fan Maxi Speed Running Duty Cycle	0~100%
F18	Cooling: Fan Min Speed	300~1300r
	Cooling: Fan Min Speed Duty Cycle	0~100%
F19	Heating: Fan Min Speed	300~1300r
	Heating: Fan Min Speed Duty Cycle	0~100%
F20	Mute Mode Speed	300~1300r
	Mute Running Duty Cycle	0~100%
F21	Timer Mute	0-[No]/1-[Yes]
F22	Manual Fan Speed	0-[No]/1-[Yes]
F23	DC Fan Rated Speed	300~1300r
	AC Fan Rated Duty Cycle	0~100%
F24	DC Fan Speed	0-[1 Fan]/ 1-[2 Fans]
D	Defrosting	
D01	Defrosting	0-[Normal]/1-[Smart II]
D02	Judge Defrosting AT	-37~45°C (-34.6-113°F)
D03	Defrosting Heating Cumulative Time	0~120min
D04	Defrosting Cycle	30~90min
D05	Adjust Defrosting Cycle Exhaust Temp	0~150°C (32-302°F)
D06	Judge Defrosting Low Pressure 1	0~45bar
D06	Judge Defrosting Low Pressure 2	0~45bar
D07	Defrost Interval Adjust Time	0~120min
D08	Sliding Defrost Star Temp	-37~45°C (-34.6-113°F)
D09	Sliding Defrost Star Suction Temp	-37~45°C (-34.6-113°F)
D10	Sliding Defrost Stop Temp	-37~45°C (-34.6-113°F)
D11	Sliding Defrost Stop Suction Temp	-37~45°C (-34.6-113°F)
D12	Sliding Defrost Adjust Exhaust Temp	0~150°C (32-302°F)
D13	Sliding Curve Small Valve Steps	0~500N
D14	Star Defrosting Water(In) Temp	4~65°C (39.2-149°F)
D15	Forced Defrosting Low Pressure	0~45bar
D16	Forced Defrosting Running Time	0~120min
D17	End Defrosting Coil(Out) Temp	-37~45°C (-34.6-113°F)
D18	End Defrosting Coil Temp	-37~45°C (-34.6-113°F)
D19	Max Defrosting Time	0~20min
D20	Defrosting Frequency	0~200Hz

Controls and Operation

Parameter List

Code	Parameter	Range
E	EEV	
E01	EEV Adjust Mode	0-[Manual]/ 1-[Auto]
E08	Defrost Steps	0~500N
E13	Cooling Section AT Setpoint	-30~80°C (-22-176°F)
E14	Cooling Section 1 Steps	0~500N
E15	Cooling Section 2 Steps	0~500N
E16	Heating Section AT Setpoint 1	-30~80°C (-22-176°F)
E17	Heating Section AT Setpoint 2	-30~80°C (-22-176°F)
E18	Heating Section 1 Superheat	-20.0~20.0°C (-4-68°F)
E19	Heating Section 2 Superheat	-20.0~20.0°C (-4-68°F)
E20	Heating Section 3 Superheat	-20.0~20.0°C (-4-68°F)
E21	EVI EEV Adjust Mode	1-[Manual]/2-[Auto]
E22	EVI Superheat	-20.0~20.0°C (-4-68°F)
E23	EVI EEV Init. Steps	0~500N
E24	EVI EEV Min Steps	0~500N
E26	Exhaust-Control Temp	60~120°C (140-248°F)
E27	End Exhaust-Control Temp	60~120°C (140-248°F)
E28	Cooling EEV Adjust Mode	0-[Fixed]/1-[Superheat]
E29	Cooling Section AT Setpoint 1	-30~80°C (-22-176°F)
E30	Cooling Section AT Setpoint 2	-30~80°C (-22-176°F)
E31	Cooling Section 1 Superheat	-20.0~20.0°C (-4-68°F)
E32	Cooling Section 2 Superheat	-20.0~20.0°C (-4-68°F)
E33	Cooling Section 3 Superheat	-20.0~20.0°C (-4-68°F)
E34	Heating Main Circuit Big Valve Init. Steps	0~500N
E35	Heating Main Circuit Small Valve Init. Steps	0~500N
E36	Main Circuit Big Valve Min Steps	0~500N
E37	Main Circuit Small Valve Min Steps	0~500N
E38	Main Circuit EEV Adjust Coefficient	2/4/20
E39	Big&Small Valve Mode To Switch AT	-30~80°C (-22-176°F)
E40	Valves Switch Superheat Return Diff	0~5°C
E41	Heating Small Valve 2nd Init. Steps AT	-37~0°C (-34.6-32°F)
E42	Heating Small Valve 2nd Init. Steps	0~500N
E43	Heating Small Valve Steps Limit AT 1	-37~0°C (-34.6-32°F)
E44	Heating Small Valve Limit Section 1 Steps	0~500N
E45	Heating Small Valve Steps Limit AT 2	-37~0°C (-34.6-32°F)
E46	Heating Small Valve Limit Section 2 Steps	0~500N
E47	Heating Small Valve Steps Limit AT 3	-37~0°C (-34.6-32°F)
E48	Heating Small Valve Limit Section 3 Steps	0~500N
R	Temperature	
R01	Heating: Inlet Water Set Temp	R21~R22
R02	Heating: Startup Return Diff	0~10°C (0-50°F)
R03	Heating: KP Coefficient	0~50
R04	Heating: Energy Demand Range Refresh	10~1800s
R05	Heating: Energy Demand Cumulative Refresh	20~1800s
R06	1 Syst. To 2 Syst. Energy Demand	0~200
R07	2 Syst. To 1 Syst. Energy Demand	0~200
R08	Heating: Max Energy Demand	0~200
R09	Cooling: Inlet Water Set Temp	R19~R20
R10	Cooling: Startup Return Diff	0~10°C (32-50°F)
R11	Cooling: KP Coefficient	0~50
R12	Cooling: Energy Demand Range Refresh	10~1800s
R13	Cooling: Energy Demand Cumulative Refresh	20~1800s
R14	Cooling: Max Energy Demand	0~200
R15	Electric Heater	0-[NO]/1-[Waterway]/2-[Tank]
R16	Electric Heating No Delay Start AT	-30.0~20.0°C (-22-68°F)
R17	Electric Heating Star Return Diff	0~10°C (0-50°F)
R18	Electric Heating Stop Return Diff	0~10°C (0-50°F)

Controls and Operation

Parameter List

Code	Parameter	Range
R19	Min Cooling Setpoint	-30.0~80.0°C (-22-176°F)
R20	Max Cooling Setpoint	-30.0~80.0°C (-22-176°F)
R21	Min Heating Setpoint	-30.0~99°C (-22-210°F)
R22	Max Heating Setpoint	-30.0~99°C (-22-210°F)
R23	Heating: Low AT For Compensate Start	-35~0°C (-35-32°F)
R24	Heating: Low AT For Compensate Stop	-38~0°C (-36.4-32°F)
R25	Heating: Max Target Temp For Low AT Compensate	20~60°C (68-140°F)
R26	Heating: High AT For Compensate Start	10~80.0°C (50-176°F)
R27	Heating: High AT For Compensate Stop	10~80.0°C (50-176°F)
R28	Heating: Max Target Temp For High AT Compensate	20~60°C (68-140°F)
P Water Pump		
P01	Mode	0-[Normal]/1-[Special]/2-[Interval]
P02	Interval	1~120min
P03	Duration	1~30min
P04	Advance	0~30min
U Flowmeter		
U01	Flowmeter	0-[No]/1-[Yes]
U02	Flowmeter 1L Water Pulse	
U03	Flowmeter Syst. (Divisor)A	-100.00~100.00
U04	Flowmeter Syst. (Subtraction)B	-100.00~100.00

If the unit has faulted, the fault icon will display on the main screen. Press the icon to bring you to the fault records screen. Refer to the fault table for troubleshooting. Once faults have been cleared/repared, you can clear the fault history by pressing "clear".

Time Setting Button

Pressing the "time setting" button allows the installer to set the current date and time. The correct time is important for fault records and setting timers.

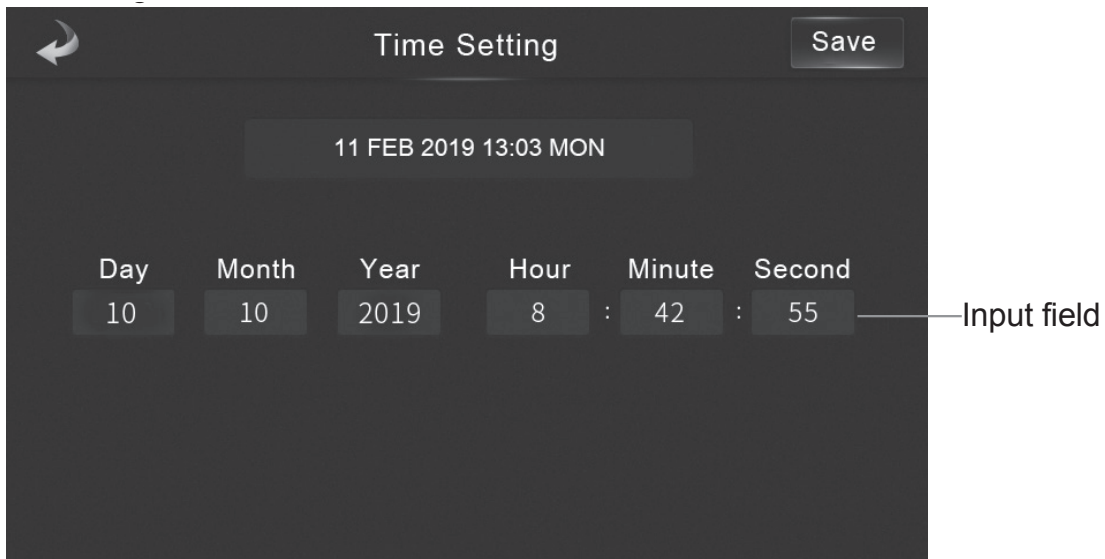

Controls and Operation

Temp Curve Button

The temp curve button records the water inlet and water outlet temperature on the unit.

Temperature data is collected every 5 minutes and the 12 sets of temperature data are saved every hour. If the power is disrupted during the hour prior to being saved, the data recorded for that hour will not be saved. A new set of data will start from the last saved time.

Electric Heat

To control an auxiliary electric heater, press the electric heat button and change selection to "On".

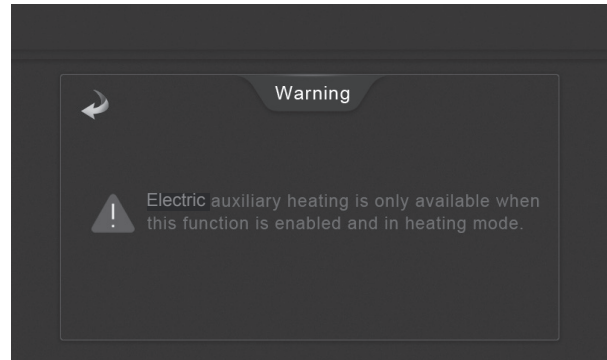
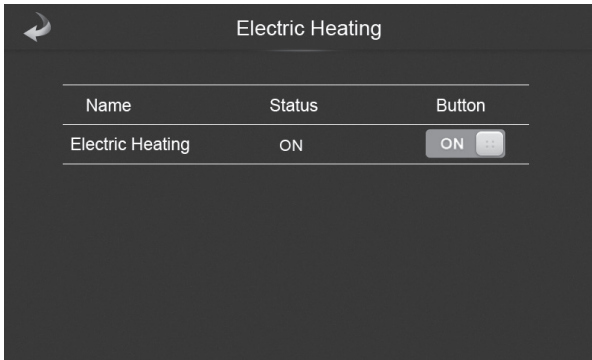

Note: Electric heat is only allowed when heating, or heating and cooling mode has been selected for unit operation, and in heating demand only.

Fast Mute Button

To enable the "Fast Mute" function, press the "Fast Mute" button (# 36 from button description table). This will slow the fans down to provide a quieter operation. However, the fast mute will also decrease capacity. Use only when quiet operation is required. To turn off, press "Fast Mute" again.

Calibrate Touch-Screen Controller

If main controller touch screen becomes dirty or damaged, perform the following to verify screen functionality. On the main home screen, press setting button, status, unit status and enter "2" for the password. Press the bottom left of the screen 10 times in 4 seconds and you should enter the display calibration screen. Press the blank squares to check if the screen has bad spots or is not functioning properly (green is normal). Click the bottom right corner of the screen to exit when completed.

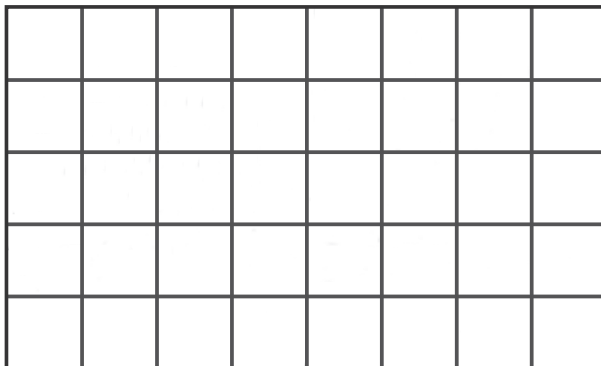

Display Calibration Interface

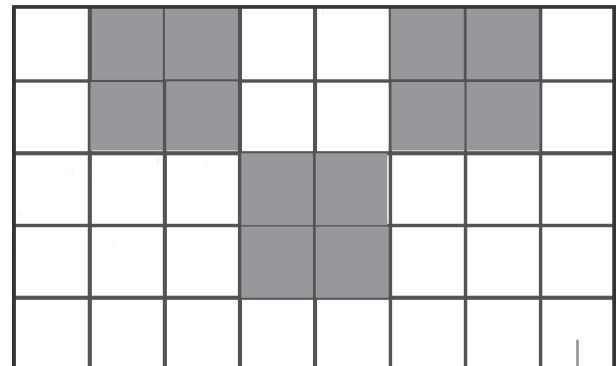

MultiTouch Detection Interface

Controls and Operation

The integrated HP control can be controlled using Modbus to perform a variety of demands. A connection to the Modbus port on the control board is required. Utilize the chart below to determine the appropriate addresses and functionality that is required for the project.

Note: If display is changed to fahrenheit or celsius, all temperature read/write will be visible in the selected temperature scale.

Table 9

TEMP1	signed byte, 0.1°C resolution, formula: T*10, temperature range -30~97°C (when displaying 25 degrees, the data on the communication according to the previous formula is 250; when displaying -25 degrees, the data on the communication according to the previous formula is -250. A 1 on bit 15 represents a negative number and a 0 on bit 15 represents a positive number. A value of 32767 represents a fault on the corresponding sensor.
DIG11	unsigned byte, multiplier 1, when displaying 123, data on the communication is 123.
DIG12	unsigned byte, multiplier 10, when displaying 1230, data on the communication is 123.
DIG13	unsigned byte, multiplier 100, when displaying 12300, data on the communication is 123.
DIG14	unsigned byte, multiplier 5, when displaying 10, data on the communication is 2.
DIG15	unsigned byte, multiplier 0.1, when displaying 12.3, data on the communication is 123.
DIG17	unsigned byte, multiplier 0.01, when displaying 1.23, data on the communication is 123.
DIG16	unsigned byte, multiplier 0.001, when displaying 0.123, data on the communication is 123.

Table 10

Address	Function	Display Paramater	Name	Byte length	Read/write	Options	Data Type		
1011	03/16		power control	double-byte	read/write	default 0 (0-shutdown/1-on)	DIG1		
1012	03/16		mode	double-byte	read/write	default 1 (0-cooling/1-heating)	DIG1		
1013	03/16		current temperature setpoint (reserved)	double-byte	read/write		TEMP1		
1014	03/16		power status (reserved)	double-byte	read/write		DIG1		
1015	03/16		operation mode (reserved)	double-byte	read/write		DIG1		
1016	03/16		current temperature (reserved)	double-byte	read/write		TEMP1		
1017	03/16		manual load control	double-byte	read/write	0-disabled/1-enabled	DIG1		
	03/16		fan 1	double-byte	read/write	0-off/1-on			
	03/16		fan 2	double-byte	read/write	0-off/1-on			
	03/16		circulation pump	double-byte	read/write	0-off/1-on			
	03/16		crankshaft heating element 1	double-byte	read/write	0-off/1-on			
	03/16		crankshaft heating element 2	double-byte	read/write	0-off/1-on			
	03/16		crankcase heating element	double-byte	read/write	0-off/1-on			
	03/16		mister valve 1	double-byte	read/write	0-off/1-on			
	03/16		mister valve 2	double-byte	read/write	0-off/1-on			
	03/16		water make-up valve (reserved)	double-byte	read/write	0-off/1-on			
	03/16		water return valve (reserved)	double-byte	read/write	0-off/1-on			
	03/16		water supply pump (reserved)	double-byte	read/write	0-off/1-on			
	1018	03/16	H01	power-loss data retention feature presence	double-byte	read/write		default 1 (0-not present/1-present)	DIG1
	1019	03/16	H02	number of systems within unit (1 compressor or 2)	double-byte	read/write		default 2 (1-single system/2-dual system)	DIG1
1020	03/16	H03	reversing valve polarity	double-byte	read/write	default 1 (0-heating powered/1-heating unpowered)	DIG1		
1021	03/16	H05	mode selection	double-byte	read/write	default 1 (0-cooling only/1-cooling and heating/2-heating)	DIG1		
1022	03/16	H06	model selection	double-byte	read/write	default 1 (0-circulating domestic hot water heater/1-North Star/4-Modular Machine)	DIG1		
1023	03/16	H07	master subordinate configuration	double-byte	read/write	default 0 (0-master/1-subordinate)	DIG1		
1024	03/16	H10	unit address	double-byte	read/write	default 1 (range 1~32)	DIG1		
1027	03/16		manual electric heating configuration	double-byte	read/write	default 0	DIG1		
1028	03/16		operation time configuration	double-byte	read/write	default 0	DIG1		
1030	03/16	H09	quiet mode configuration	double-byte	read/write	default 0 (0-disabled/1-enabled)	DIG1		
1035	03/16	H25	compressor activation delay due to reversing valve actuation	double-byte	read/write	default 60s (range 0~60s)	DIG1		
1036	03/16	H27	compressor model selection	double-byte	read/write	default 2 (range 1~10)	DIG1		
1037	03/16	A01	compressor low ambient shutdown temperature	double-byte	read/write	default -37°C (range -37.0~10.0°C)	TEMP1		
1038	03/16	A02	water supply freeze protection setpoint	double-byte	read/write	default 4°C (range -15.0~10.0°C)	TEMP1		
1040	03/16	A03	vapor supply temperature protection setpoint	double-byte	read/write	default 115°C (range 60.0~130.0°C)	TEMP1		
1041	03/16	A04	refrigerant type	double-byte	read/write	default 0 (0-R410A/1-R22/2-R134a/3-R407C)	DIG1		
1042	03/16	A05	pressure sensor configuration	double-byte	read/write	default 1 (0-disabled/1-enabled)	DIG1		
1054	03/16	A07	water supply overtemperature protection setpoint	double-byte	read/write	default 65°C (range 40~65°C)	TEMP1		
1055	03/16	A08	water delta temperature protection setpoint	double-byte	read/write	default 13°C (range 0~25°C)	TEMP1		
1056	03/16	A09	refrigerant leakage pressure setpoint	double-byte	read/write	default 0bar (range 0~5bar)	DIG5		
1057	03/16	A06	low water flow protection setpoint	double-byte	read/write	default 3m³/h (range 0~50m³/h)	DIG1		
1058	03/16	H29	quiet mode compressor maximum frequency	double-byte	read/write	default 80Hz (range 0~150Hz)	DIG1		
1059	03/16	F01	fan configuration	double-byte	read/write	default 1 (0-single speed/1-dual speed/2-AC/3-DC (variable speed))	DIG1		
1060	03/16	F02	cooling mode coil temperature for high speed fan operation	double-byte	read/write	default 40°C (range -15.0~60.0°C)	TEMP1		
1061	03/16	F02	cooling mode high-side pressure for high speed fan operation	double-byte	read/write	default 23bar (range 0~50bar)	DIG5		
1062	03/16	F03	cooling mode coil temperature for low speed fan operation	double-byte	read/write	default 30°C (range -15.0~60.0°C)	TEMP1		
1063	03/16	F03	cooling mode high-side pressure for low speed fan operation	double-byte	read/write	default 15bar (range 0~50bar)	DIG5		
1064	03/16	F04	cooling mode coil temperature for fan shutdown	double-byte	read/write	default 10°C (range -15.0~60.0°C)	TEMP1		
1065	03/16	F04	cooling mode high-side pressure for fan shutdown	double-byte	read/write	default 2bar (range 0~50bar)	DIG5		
1066	03/16	F05	heating mode coil temperature for high speed fan operation	double-byte	read/write	default 10°C (range -15.0~60.0°C)	TEMP1		
1067	03/16	F05	heating mode low-side pressure for high speed fan operation	double-byte	read/write	default 10bar (range 0~30bar)	DIG5		
1068	03/16	F06	heating mode coil temperature for low speed fan operation	double-byte	read/write	default 20°C (range -15.0~60.0°C)	TEMP1		
1069	03/16	F06	heating mode low-side pressure for low speed fan operation	double-byte	read/write	default 12bar (range 0~30bar)	DIG5		
1070	03/16	F07	heating mode coil temperature for fan shutdown	double-byte	read/write	default 30°C (range -15.0~60.0°C)	TEMP1		
1071	03/16	F07	heating mode low-side pressure for fan shutdown	double-byte	read/write	default 17bar (range 0~30bar)	DIG5		
1072	03/16	F08	quiet mode start time	double-byte	read/write	default 0h (range 0~23h)	DIG1		
1073	03/16	F09	quiet mode end time	double-byte	read/write	default 6h (range 0~23h)	DIG1		
1074	03/16	F10	number of fans	double-byte	read/write	default 1 (0-single fan/1-dual fan)	DIG1		
1075	03/16	F11	fan speed control configuration	double-byte	read/write	default 0 (0-coil/1-pressure)	DIG1		
1076	03/16	F15	high ambient fan shutdown ambient temperature	double-byte	read/write	default 35°C (range 20~80°C)	TEMP1		
1077	03/16	F16	fan (heat source pump) activation advancement preceding compressor activation	double-byte	read/write	default 1min (range 0~120min)	DIG1		
1078	03/16	F17	AC fan duty cycle at maximum speed	double-byte	read/write	default 100% (range the larger of F18/F19~100%)	DIG1		
1079	03/16	F17	DC fan maximum speed	double-byte	read/write	default 1060r (range the larger of F18/F19~1300r)	DIG1		

Controls and Operation

Address	Function	Display Parameter	Name	Byte length	Read/write	Options	Data Type
1080	03/16	F18	cooling duty cycle at minimum fan speed	double-byte	read/write	default 50% (range 0-F17%)	DIG1
1081	03/16	F18	cooling minimum fan speed	double-byte	read/write	default 600r (range 300-F17r)	DIG1
1082	03/16	F19	heating duty cycle at minimum fan speed	double-byte	read/write	default 50% (range 0-F17%)	DIG1
1083	03/16	F19	heating minimum fan speed	double-byte	read/write	default 600r (range 300-F17r)	DIG1
1084	03/16	F20	quiet mode duty cycle	double-byte	read/write	default 50% (range 0-100%)	DIG1
1085	03/16	F20	quiet mode speed	double-byte	read/write	default 600r (range 300-1300r)	DIG1
1086	03/16	F21	quiet mode timer configuration	double-byte	read/write	default 0 (0-disabled/1-enabled)	DIG1
1087	03/16	F22	manual fan speed/manual low-speed configuration	double-byte	read/write	default 0 (0-disabled/1-enabled)	DIG1
1088	03/16	F23	AC fan rated duty cycle	double-byte	read/write	default 50% (range 0-100%)	DIG1
1089	03/16	F23	DC fan rated speed	double-byte	read/write	default 600r (range 300-1300r)	DIG1
1090	03/16		one-key quiet mode configuration	double-byte	read/write	default 0	DIG1
1101	03/16	F15	high ambient fan shutdown pressure	double-byte	read-only	default 4bar (range 0-15bar)	DIG5
1102	03/16	F24	number of DC fan speed control boards	double-byte	read-only	default 0 (0-single module/1-dual module)	DIG1
1103	03/16	H28	water temperature control mode	double-byte	read-only	default 0 (0-water return/1-water supply)	DIG1
1131	03/16	E01	heating mode electronic expansion valve control mode	double-byte	read-only	default 1 (0-manual/1-automatic)	DIG1
1134	03/16	E08	defrost position	double-byte	read-only	default 480N (range 0-500N)	DIG1
1136	03/16	E13	cooling band ambient temperature setpoint	double-byte	read-only	default 0°C (range -30-80°C)	TEMP1
1137	03/16	E14	cooling band 1 initial position	double-byte	read-only	default 350N (range 0-500N)	DIG1
1138	03/16	E15	cooling band 2 initial position	double-byte	read-only	default 350N (range 0-500N)	DIG1
1139	03/16	E16	heating band ambient temperature setpoint 1	double-byte	read-only	default -15°C (range -30-E17°C)	TEMP1
1140	03/16	E17	heating band ambient temperature setpoint 2	double-byte	read-only	default -5°C (range E16-80°C)	TEMP1
1141	03/16	E18	heating band 1 overtemperature	double-byte	read-only	default 3°C (range -20.0-20.0°C)	TEMP1
1142	03/16	E19	heating band 2 overtemperature	double-byte	read-only	default 3°C (range -20.0-20.0°C)	TEMP1
1143	03/16	E20	heating band 3 overtemperature	double-byte	read-only	default 3°C (range -20.0-20.0°C)	TEMP1
1144	03/16	E21	EVI electronic expansion valve control mode	double-byte	read-only	default 1 (1-manual/2-automatic)	DIG1
1145	03/16	E22	EVI overtemperature	double-byte	read-only	default 3°C (range -20.0-20.0°C)	TEMP1
1146	03/16	E23	EVI electronic expansion valve initial position	double-byte	read-only	default 200N (range 0-500N)	DIG1
1147	03/16	E24	EVI electronic expansion valve minimum position	double-byte	read-only	default 100N (range 0-500N)	DIG1
1149	03/16	E26	EVI electronic expansion valve high discharge control activation temperature	double-byte	read-only	default 105°C (range 60-120°C)	TEMP1
1150	03/16	E27	EVI electronic expansion valve high discharge control deactivation temperature	double-byte	read-only	default 95°C (range 60-120°C)	TEMP1
1151	03/16	E28	cooling mode electronic expansion valve control mode	double-byte	read-only	default 1 (0-fixed/1-overtemperature control)	DIG1
1152	03/16	E29	cooling band ambient temperature setpoint 1	double-byte	read-only	default 21°C (range -30-E30°C)	TEMP1
1153	03/16	E30	cooling band ambient temperature setpoint 2	double-byte	read-only	default 35°C (range E29-80°C)	TEMP1
1154	03/16	E31	cooling band 1 overtemperature	double-byte	read-only	default 3°C (range -20.0-20.0°C)	TEMP1
1155	03/16	E32	cooling band 2 overtemperature	double-byte	read-only	default 3°C (range -20.0-20.0°C)	TEMP1
1156	03/16	E33	cooling band 3 overtemperature	double-byte	read-only	default 3°C (range -20.0-20.0°C)	TEMP1
1158	03/16	R09	cooling mode return temperature setpoint	double-byte	read-only	default 25°C (range R19-R20°C)	TEMP1
1159	03/16	R01	heating mode return temperature setpoint	double-byte	read-only	default 50°C (range R21-R22°C)	TEMP1
1160	03/16	R02	heating mode activation temperature hysteresis	double-byte	read-only	default 2°C (range 0-10°C)	TEMP1
1162	03/16	R19	cooling mode setpoint minimum	double-byte	read-only	default 8°C (range -30.0-R20°C)	TEMP1
1163	03/16	R20	cooling mode setpoint maximum	double-byte	read-only	default 35°C (range R19-80.0°C)	TEMP1
1164	03/16	R21	heating mode setpoint minimum	double-byte	read-only	default 5°C (range -30.0-R22°C)	TEMP1
1165	03/16	R22	heating mode setpoint maximum	double-byte	read-only	default 55°C (range R21-99°C)	TEMP1
1166	03/16	R16	ambient temperature for immediate electric heating activation	double-byte	read-only	default -15°C (range -30.0-20.0°C)	TEMP1
1167	03/16	R23	low ambient heating compensation starting ambient temperature	double-byte	read-only	default -20°C (range R24-0°C)	
1168	03/16	R24	low ambient heating compensation ending ambient temperature	double-byte	read-only	default -37°C (range -35-R23°C)	
1169	03/16	R25	low ambient heating compensation highest target temperature	double-byte	read-only	default 40°C (range 20-60°C)	
1170	03/16	R26	high temperature heating compensation starting ambient temperature	double-byte	read-only	default 55°C (range 10-R27°C)	
1171	03/16	R27	high temperature heating compensation ending ambient temperature	double-byte	read-only	default 55°C (range R26-80.0°C)	
1172	03/16	R28	high temperature heating compensation highest target temperature	double-byte	read-only	default 62°C (range 20-60°C)	
1173	03/16	R15	electric heating configuration	double-byte	read-only	default 0 (0-disabled/1-space heating/2-domestic hot water)	DIG1
1174	03/16	R10	cooling mode activation temperature hysteresis	double-byte	read-only	default 2°C (range 0-10°C)	TEMP1
1191	03/16	L14	(cooling) second stage timed temperature control start time	double-byte	read-only	default 0h (range 0-23h)	DIG1
1192	03/16	L15	(cooling) second stage timed temperature control end time	double-byte	read-only	default 0h (range 0-23h)	DIG1
1193	03/16	U01	flow meter configuration	double-byte	read-only	default 1 (0-disabled/1-enabled)	DIG1
1194	03/16	U02	flow meter number of pulses per liter	double-byte	read-only	(reserved feature)	DIG1
1195	03/16	U03	flow meter parameter (divisor) a	double-byte	read-only	default 16.500 (-32.000-32.000)	DIG7
1196	03/16	U04	flow meter parameter (subtractor) b	double-byte	read-only	default 1.950 (-32.000-32.000)	DIG7
1197	03/16	P01	circulation pump mode of operation	double-byte	read-only	default 2 (0-normal/1-special/2-interval)	DIG1
1198	03/16	P02	circulation pump operation interval	double-byte	read-only	default 30min (range 1-120min)	DIG1
1199	03/16	P03	circulation pump operation duration	double-byte	read-only	default 3min (range 1-30min)	DIG1
1200	03/16	P04	circulation pump activation advancement preceding compressor activation	double-byte	read-only	default 1min (range 0-30min)	DIG1
1201	03/16	L09	(cooling) first stage timed temperature control enable	double-byte	read-only	default 0 (0-disabled/1-enabled)	DIG1
1202	03/16	L10	(cooling) first stage timed temperature control start time	double-byte	read-only	default 0h (range 0-23h)	DIG1
1203	03/16	L11	(cooling) first stage timed temperature control end time	double-byte	read-only	default 0h (range 0-23h)	DIG1
1204	03/16	L12	(cooling) first stage timed temperature control setpoint	double-byte	read-only	default 21°C (range R19-R20°C)	TEMP1
1205	03/16	L13	(cooling) second stage timed temperature control enable	double-byte	read-only	default 0 (0-disabled/1-enabled)	DIG1
1210	03/16	D14	defrost water return temperature	double-byte	read-only	default 15°C (range 4-65°C)	TEMP1
1211	03/16	D15	forced defrost low-side starting pressure	double-byte	read-only	default 2bar (range 0-45bar)	DIG5
1212	03/16	D16	forced defrost operation time	double-byte	read-only	default 120min (range 0-120min)	DIG1
1213	03/16	D17	coil outlet defrost ending temperature	double-byte	read-only	default 33°C (range -37-45°C)	TEMP1
1214	03/16	D18	coil defrost ending temperature	double-byte	read-only	default 30°C (range -37-45°C)	TEMP1
1215	03/16	D19	maximum defrost time	double-byte	read-only	default 8min (range 0-20min)	DIG1
1216	03/16	D13	ambient-temperature-based defrost curve correction small valve position	double-byte	read-only	default 165N (range 0-500N)	DIG1
1217	03/16	D20	defrost frequency	double-byte	read-only	default 80Hz (range 0-200Hz)	DIG1
1218	03/16	L16	(cooling) second stage timed temperature control setpoint	double-byte	read-only	default 21°C (range R19-R20°C)	TEMP1
1219	03/16	L01	(heating) first stage timed temperature control enable	double-byte	read-only	default 0 (0-disabled/1-enabled)	DIG1
1220	03/16	L02	(heating) first stage timed temperature control start time	double-byte	read-only	default 21h (range 0-23h)	DIG1
1221	03/16	L03	(heating) first stage timed temperature control end time	double-byte	read-only	default 7h (range 0-23h)	DIG1
1222	03/16	L04	(heating) first stage timed temperature control setpoint	double-byte	read-only	default 55°C (range R21-R22°C)	TEMP1
1223	03/16	L05	(heating) second stage timed temperature control enable	double-byte	read-only	default 0 (0-disabled/1-enabled)	DIG1
1224	03/16	L06	(heating) second stage timed temperature control start time	double-byte	read-only	default 7h (range 0-23h)	DIG1

Controls and Operation

Address	Function	Display Parameter	Name	Byte length	Read/write	Options	Data Type
1225	03/16	L07	(heating) second stage timed temperature control end time	double-byte	read-only	default 21h (range 0~23h)	DIG1
1226	03/16	L08	(heating) second stage timed temperature control setpoint	double-byte	read-only	default 45°C (range R21~R22°C)	TEMP1
1227	03/16	E35	heating mode main circuit small valve initial position	double-byte	read-only	default 350N (range 0~500N)	DIG1
1228	03/16	E36	main circuit large valve minimum position	double-byte	read-only	default 60N (range 0~500N)	DIG1
1229	03/16	E37	main circuit small valve minimum position	double-byte	read-only	default 100N (range 0~500N)	DIG1
1230	03/16	E38	main circuit electronic expansion valve adjustment coefficient	double-byte	read-only	default 2 (range 2-4)	DIG1
1231	03/16	E39	large small valve mode exchange ambient temperature (heating)	double-byte	read-only	default 0°C (range -30~80°C)	TEMP1
1232	03/16	E40	large small valve mode exchange overtemperature hysteresis	double-byte	read-only	default 1°C (range 0~5°C)	TEMP1
1233	03/16	E41	heating mode small valve second initial position ambient temperature	double-byte	read-only	default -20°C (range -37~0°C)	TEMP1
1234	03/16	E42	heating mode small valve second initial position	double-byte	read-only	default 200N (range 0~500N)	DIG1
1235	03/16	E43	heating mode small valve position limit 1 ambient temperature	double-byte	read-only	default -30°C (range -37~0°C)	TEMP1
1236	03/16	E44	heating mode small valve position limit 1	double-byte	read-only	default 120N (range 0~500N)	DIG1
1237	03/16	E45	heating mode small valve position limit 2 ambient temperature	double-byte	read-only	default -25°C (range -37~0°C)	TEMP1
1238	03/16	E46	heating mode small valve position limit 2	double-byte	read-only	default 250N (range 0~500N)	DIG1
1239	03/16	E47	heating mode small valve position limit 3 ambient temperature	double-byte	read-only	default -15°C (range -37~0°C)	TEMP1
1240	03/16	E48	heating mode small valve position limit 3	double-byte	read-only	default 350N (range 0~500N)	DIG1
1241	03/16	R03	heating mode Kp gain	double-byte	read-only	default 10 (range 0~50)	DIG1
1242	03/16	R04	heating mode demand band refresh interval	double-byte	read-only	default 10s (range 10~1800s)	DIG1
1243	03/16	R05	heating mode demand accumulation refresh interval	double-byte	read-only	default 40s (range 20~1800s)	DIG1
1244	03/16	R06	single->dual demand	double-byte	read-only	default 26 (range 0~200)	DIG1
1245	03/16	R07	dual->single demand	double-byte	read-only	default 21 (range 0~200)	DIG1
1246	03/16	R08	heating mode maximum demand	double-byte	read-only	default 106 (range 0~200)	DIG1
1247	03/16	R11	cooling mode Kp gain	double-byte	read-only	default 10 (range 0~50)	DIG1
1248	03/16	R12	cooling mode demand band refresh interval	double-byte	read-only	default 10s (range 10~1800s)	DIG1
1249	03/16	R13	cooling mode demand accumulation refresh interval	double-byte	read-only	default 40s (range 20~1800s)	DIG1
1250	03/16	E34	heating mode main circuit large valve initial position	double-byte	read-only	default 200N (range 0~500N)	DIG1
1252	03/16	R14	cooling mode maximum demand	double-byte	read-only	default 87 (range 0~200)	DIG1
1253	03/16	R17	electric heating activation hysteresis	double-byte	read-only	default 5°C (range 0~10°C)	TEMP1
1254	03/16	R18	electric heating deactivation hysteresis	double-byte	read-only	default 5°C (range 0~10°C)	TEMP1
1258	03/16	D01	defrost type	double-byte	read-only	default 1 (0-normal defrost/1-intelligent defrost II)	DIG1
1259	03/16	D02	defrost decision ambient temperature	double-byte	read-only	default 12.5°C (range -37~45°C)	TEMP1
1260	03/16	D03	accumulated defrost heating time	double-byte	read-only	default 26min (range 0~120min)	DIG1
1261	03/16	D04	defrost interval	double-byte	read-only	default 45min (range 30~90min)	DIG1
1262	03/16	D05	defrost interval vapor supply temperature correction	double-byte	read-only	default 110°C (range 0~150°C)	DIG5
1263	03/16	D06	defrost decision low-side pressure 1	double-byte	read-only	default 2.6bar (range 0~45bar)	DIG5
1264	03/16	D06	defrost decision low-side pressure 2	double-byte	read-only	default 1.7bar (range 0~45bar)	TEMP1
1265	03/16	D07	defrost interval correction time	double-byte	read-only	default 15min (range 0~120min)	DIG1
1266	03/16	D08	ambient-temperature-based defrost starting temperature	double-byte	read-only	default 6.1°C (range -37~45°C)	TEMP1
1267	03/16	D09	ambient-temperature-based defrost starting vapor return temperature	double-byte	read-only	default -4.1°C (range -37~45°C)	TEMP1
1268	03/16	D10	ambient-temperature-based defrost ending temperature	double-byte	read-only	default -26.1°C (range -37~45°C)	TEMP1
1269	03/16	D11	ambient-temperature-based defrost ending vapor return temperature	double-byte	read-only	default -28.1°C (range -37~45°C)	TEMP1
1270	03/16	D12	ambient-temperature-based defrost curve correction vapor supply temperature	double-byte	read-only	default 100°C (range 0~150°C)	TEMP1
2011	16		power status	double-byte	read-only	0-shutdown/1-on	DIG1
2012	16		operation mode	double-byte	read-only	0-cooling/1-heating/250-defrost	DIG1
2013	16		current temperature	double-byte	read-only		TEMP1
2014	16		up time in days	double-byte	read-only		DIG1
2015	16		main program version number	double-byte	read-only	data on the communication being 11	DIG5
2016	16		build number	double-byte	read-only	data on the communication being 117, represents build number 82400117	DIG1
2017	16		VFD board 1 program version number	double-byte	read-only	data on the communication being 001, represents version number V1	DIG1
2018	16		VFD board 2 program version number	double-byte	read-only	data on the communication being 001, represents version number V1	DIG1
2019	16		timed peak-shaving temperature control status	double-byte	read-only		DIG1
2020	16		quiet mode status (0-inactive/1-active)	double-byte	read-only		DIG1
2023	16	T01	water return temperature	double-byte	read-only	-30~97°C	TEMP1
2024	16	T02	water supply temperature	double-byte	read-only	-30~97°C	TEMP1
2026	16	T05	ambient temperature	double-byte	read-only	-50~60°C	TEMP1
2027	16	T08	system 1 coil temperature 1	double-byte	read-only	-50~60°C	TEMP1
2028	16	T09	system 1 coil temperature 2	double-byte	read-only	-50~60°C	TEMP1
2031	16	T20	system 2 coil temperature 1	double-byte	read-only	-50~60°C	TEMP1
2032	16	T21	system 2 coil temperature 2	double-byte	read-only	-50~60°C	TEMP1
2043	16	T07	system 1 vapor return temperature	double-byte	read-only	-50~60°C	TEMP1
2044	16	T19	system 2 vapor return temperature	double-byte	read-only	-50~60°C	TEMP1
2047	16	T14	system 1 vapor supply temperature	double-byte	read-only		TEMP1
2048	16	T26	system 2 vapor supply temperature	double-byte	read-only		TEMP1
2051	16	T12	system 1 EVI inlet temperature	double-byte	read-only	-30~97°C	TEMP1
2052	16	T24	system 2 EVI inlet temperature	double-byte	read-only	-30~97°C	TEMP1
2055	16	T13	system 1 EVI outlet temperature	double-byte	read-only	-30~97°C	TEMP1
2056	16	T25	system 2 EVI outlet temperature	double-byte	read-only	-30~97°C	TEMP1
2059	16	T03	system 1 freeze protection temperature	double-byte	read-only	-30~97°C	TEMP1
2063	16	T04	system 2 freeze protection temperature	double-byte	read-only	-30~97°C	TEMP1
2075	16	O15	system 1 electronic expansion valve large valve position	double-byte	read-only	0~500N	DIG1
2076	16	O18	system 2 electronic expansion valve large valve position	double-byte	read-only	0~500N	DIG1
2079	16	O17	system 1 EVI electronic expansion valve position	double-byte	read-only	0~500N	DIG1
2080	16	O20	system 2 EVI electronic expansion valve position	double-byte	read-only	0~500N	DIG1
2087	16	T17	system 1 low-side pressure	double-byte	read-only	0~60bar	DIG5
2088	16	T29	system 2 low-side pressure	double-byte	read-only	0~60bar	DIG5
2101	16	O16	system 1 electronic expansion valve small valve position	double-byte	read-only	0~500N	DIG1
2102	16	O19	system 2 electronic expansion valve small valve position	double-byte	read-only	0~500N	DIG1
2103	16	T06	system 1 coil supply temperature	double-byte	read-only	-50~60°C	TEMP1
2104	16	T18	system 2 coil supply temperature	double-byte	read-only	-50~60°C	TEMP1
2105	16	O21	power demand	double-byte	read-only	0~200	DIG1
2109	16	T16	system 1 high-side pressure	double-byte	read-only	0~60bar	DIG5
2110	16	T28	system 2 high-side pressure	double-byte	read-only	0~60bar	DIG5
2111	16	T10	system 1 evaporator temperature	double-byte	read-only	-45~34°C	TEMP1
2112	16	T11	system 1 overtemperature	double-byte	read-only	-30~97°C	TEMP1

Controls and Operation

Address	Function	Display Parameter	Name	Byte length	Read/write	Options	Data Type
2113	16	T22	system 1 evaporator temperature	double-byte	read-only	-45~34°C	TEMP1
2114	16	T23	system 2 overtemperature	double-byte	read-only	-30~97°C	TEMP1
2117	16	T30	unit water flow	double-byte	read-only	0~100m ³ /h	DIG5
2118	16	O124	unit online status	double-byte	read-only	0-offline/1-online	DIG1
2122	16	I18	system 1 fan speed	double-byte	read-only	0~1300r	DIG1
2123	16	I24	system 2 fan speed	double-byte	read-only	0~1300r	DIG1
2126	16	I01	system 1 compressor frequency setpoint	double-byte	read-only	0~200Hz	DIG1
2127	16	I02	system 1 compressor operation frequency	double-byte	read-only	0~200Hz	DIG1
2128	16	I03	system 1 VFD board phase current	double-byte	read-only	0~100A	DIG5
2129	16	I04	system 1 VFD board IPM temperature	double-byte	read-only	0~150°C	DIG1 (Value: 0~255=- 55~200°C)
2130	16	I05	system 1 VFD board bus voltage	double-byte	read-only	0~1000V	DIG1
2131	16	I06	system 1 VFD board operation status	double-byte	read-only	0~65536	DIG1
2132	16	I07	system 1 VFD board fault status 1	double-byte	read-only	0~65536	DIG1
2133	16	I08	system 1 VFD board fault status 2	double-byte	read-only	0~65536	DIG1
2134	16	I09	system 2 compressor frequency setpoint	double-byte	read-only	0~200Hz	DIG1
2135	16	I10	system 2 compressor operation frequency	double-byte	read-only	0~200Hz	DIG1
2136	16	I11	system 2 VFD board phase current	double-byte	read-only	0~100A	DIG5
2137	16	I12	system 2 VFD board IPM temperature	double-byte	read-only	0~150°C	DIG1 (Value: 0~255=- 55~200°C)
2138	16	I13	system 2 VFD board bus voltage	double-byte	read-only	0~1000V	DIG1
2139	16	I14	system 2 VFD board operation status	double-byte	read-only	0~65536	DIG1
2140	16	I15	system 2 VFD board fault status 1	double-byte	read-only	0~65536	DIG1
2141	16	I16	system 2 VFD board fault status 2	double-byte	read-only	0~65536	DIG1
2142	16	I17	system 1 fan speed setpoint	double-byte	read-only	0~1300r	DIG1
2143	16	I19	system 1 fan phase current	double-byte	read-only	0~50A	DIG5
2144	16	I20	system 1 fan IPM temperature	double-byte	read-only	-20~150°C	TEMP1
2145	16	I21	system 1 fan bus voltage	double-byte	read-only	0~1000V	DIG1
2146	16	I22	system 1 fan fault status	double-byte	read-only	0~65536	DIG1
2147	16	I23	system 2 fan speed setpoint	double-byte	read-only	0~1300r	DIG1
2148	16	I25	system 2 fan phase current	double-byte	read-only	0~50A	DIG5
2149	16	I26	system 2 fan IPM temperature	double-byte	read-only	-20~150°C	TEMP1
2150	16	I27	system 2 fan bus voltage	double-byte	read-only	0~1000V	DIG1
2151	16	I28	system 2 fan fault status	double-byte	read-only	0~65536	DIG1
2156	16	T31	unit status	double-byte	read-only	0~500kW	DIG5
2157	16	T15	system 1 condensor temperature	double-byte	read-only	-30~97°C	TEMP1
2158	16	T27	system 2 condensor temperature	double-byte	read-only	-30~97°C	TEMP1
2159	16	bit0	F151 system 1 compressor communication fault	double-byte	read-only		DIG1
	16	bit1	F152 system 1 compressor failed to start	double-byte	read-only		
	16	bit2	F153 system 1 starting IPM protection fault	double-byte	read-only		
	16	bit3	F154 system 1 running IPM protection fault	double-byte	read-only		
	16	bit4	F156 system 1 compressor overcurrent protection fault	double-byte	read-only		
	16	bit5	F155 compressor 1 IPM overtemperature protection fault	double-byte	read-only		
	16	bit6	F157 compressor 1 bus overvoltage protection fault	double-byte	read-only		
	16	bit7	F158 compressor 1 bus undervoltage protection fault	double-byte	read-only		
	16	bit8	F251 system 2 compressor communication fault	double-byte	read-only		
	16	bit9	F252 system 2 compressor failed to start	double-byte	read-only		
	16	bit10	F253 system 2 starting IPM protection fault	double-byte	read-only		
	16	bit11	F254 system 2 running IPM protection fault	double-byte	read-only		
	16	bit12	F256 system 2 compressor overcurrent protection fault	double-byte	read-only		
	16	bit13	F255 compressor 2 IPM overtemperature protection fault	double-byte	read-only		
	16	bit14	F257 compressor 2 bus overvoltage protection fault	double-byte	read-only		
	16	bit15	F258 compressor 2 bus undervoltage protection fault	double-byte	read-only		
2160	16	bit0	F101 fan 1 output loss-of-phase-power protection fault	double-byte	read-only		DIG1
	16	bit1	F102 fan 1 output zero-speed protection fault	double-byte	read-only		
	16	bit2	F103 fan 1 starting IPM protection fault	double-byte	read-only		
	16	bit3	F104 fan 1 running IPM protection fault	double-byte	read-only		
	16	bit4	F105 fan 1 overcurrent protection fault	double-byte	read-only		
	16	bit5	F106 fan 1 overtemperature protection fault	double-byte	read-only		
	16	bit6	F107 fan 1 bus overvoltage protection fault	double-byte	read-only		
	16	bit7	F108 fan 1 bus undervoltage protection fault	double-byte	read-only		
	16	bit8	F201 fan 2 output loss-of-phase-power protection fault	double-byte	read-only		
	16	bit9	F202 fan 2 output zero-speed protection fault	double-byte	read-only		
	16	bit10	F203 fan 2 starting IPM protection fault	double-byte	read-only		
	16	bit11	F204 fan 2 running IPM protection fault	double-byte	read-only		
	16	bit12	F205 fan 2 overcurrent protection fault	double-byte	read-only		
	16	bit13	F206 fan 2 overtemperature protection fault	double-byte	read-only		
	16	bit14	F207 fan 2 bus overvoltage protection fault	double-byte	read-only		
	16	bit15	F208 fan 2 bus undervoltage protection fault	double-byte	read-only		
2161	16	bit0	E081 DC fan board 1 communication fault	double-byte	read-only		DIG1
	16	bit1	E082 DC fan board 2 communication fault	double-byte	read-only		
	16	bit2	E121 system 1 reversing valve abnormal operation	double-byte	read-only		
	16	bit3	E221 system 2 reversing valve abnormal operation	double-byte	read-only		
2162	16	O03	O03 system 1 fan	double-byte	read-only	0-off/1-high speed/2-low speed	DIG1
2163	16	O04	O04 system 2 fan	double-byte	read-only	0-off/1-high speed/2-low speed	DIG1
2164	16	bit0	O01 system 1 compressor (0-off/1-on)	double-byte	read-only		DIG1
	16	bit1	O02 system 2 compressor (0-off/1-on)	double-byte	read-only		
	16	bit8	O05 circulation pump output (0-off/1-on)	double-byte	read-only		
	16	bit9	O06 system 1 reversing valve (0-off/1-on)	double-byte	read-only		
	16	bit10	O07 system 2 reversing valve (0-off/1-on)	double-byte	read-only		
	16	bit11	O08 electric heating (0-off/1-on)	double-byte	read-only		
	16	bit5	O13 alarm output (0-off/1-on)	double-byte	read-only		
	16	bit6	O14 crankcase heating element output (0-off/1-on)	double-byte	read-only		
	16	bit7	O09 system 1 crankshaft heating element output (0-off/1-on)	double-byte	read-only		
	16	bit8	O10 system 2 crankshaft heating element output (0-off/1-on)	double-byte	read-only		
	16	bit9	O11 system 1 mister valve output (0-off/1-on)	double-byte	read-only		
	16	bit10	O12 system 2 mister valve output (0-off/1-on)	double-byte	read-only		

Controls and Operation

Address	Function	Display Parameter	Name	Byte length	Read/write	Options	Data Type		
2167	16	bit0	S01 system 1 overpressure switch (0-closed/1-open)	double-byte	read-only		DIG11		
	16	bit1	S03 system 2 overpressure switch (0-closed/1-open)	double-byte	read-only				
	16	bit4	S02 system 1 underpressure switch (0-closed/1-open)	double-byte	read-only				
	16	bit5	S04 system 2 underpressure switch (0-closed/1-open)	double-byte	read-only				
	16	bit9	S05 water flow switch (0-closed/1-open)	double-byte	read-only				
	16	bit10	S07 mode switch (0-closed/1-open)	double-byte	read-only				
	16	bit11	S08 electric heating overload protection switch (0-closed/1-open)	double-byte	read-only				
	16	bit12	S06 emergency switch (0-closed/1-open)	double-byte	read-only				
	16	bit13	S09 system 1 fan overload protection switch (0-closed/1-open)	double-byte	read-only				
	16	bit14	S10 system 2 fan overload protection switch (0-closed/1-open)	double-byte	read-only				
2169	1	bit0	P01 water return temperature sensor fault	double-byte	read-only		DIG11		
	2	bit1	P02 water supply temperature sensor fault	double-byte	read-only				
	3	bit2	P03 domestic hot water temperature sensor fault	double-byte	read-only	new in domestic hot water			
	4	bit3	P04 ambient temperature sensor fault	double-byte	read-only				
	5	bit4	P17 system 1 vapor return temperature sensor fault	double-byte	read-only				
	6	bit5	P27 system 2 vapor return temperature sensor fault	double-byte	read-only				
	9	bit8	P181 system 1 vapor supply temperature sensor fault	double-byte	read-only				
	10	bit9	P281 system 2 vapor supply temperature sensor fault	double-byte	read-only				
	13	bit12	P101 system 1 EVI inlet temperature sensor fault	double-byte	read-only				
	14	bit13	P201 system 2 EVI inlet temperature sensor fault	double-byte	read-only				
	17	bit0	P102 system 1 EVI outlet temperature sensor fault	double-byte	read-only				
	18	bit1	P202 system 2 EVI outlet temperature sensor fault	double-byte	read-only				
	21	bit4	P191 system 1 user-side freeze protection 1 temperature sensor fault	double-byte	read-only				
	25	bit8	P291 system 2 user-side freeze protection 1 temperature sensor fault	double-byte	read-only				
2170	37	bit4	P150 system 1 coil temperature sensor 1 fault	double-byte	read-only		DIG11		
	38	bit5	P154 system 1 coil temperature sensor 2 fault	double-byte	read-only				
	41	bit8	P250 system 2 coil temperature sensor 1 fault	double-byte	read-only				
	42	bit9	P254 system 2 coil temperature sensor 2 fault	double-byte	read-only				
	53	bit4	PP11 system 1 low-side pressure sensor fault	double-byte	read-only				
	54	bit5	PP21 system 2 low-side pressure sensor fault	double-byte	read-only				
	57	bit8	P182 system 1 vapor supply overtemperature protection fault	double-byte	read-only				
	58	bit9	P282 system 2 vapor supply overtemperature protection fault	double-byte	read-only				
	61	bit12	E11 system 1 overpressure protection fault	double-byte	read-only				
	62	bit13	E21 system 2 overpressure protection fault	double-byte	read-only				
	2173	65	bit0	E12 system 1 underpressure protection fault	double-byte	read-only			DIG11
		66	bit1	E22 system 2 underpressure protection fault	double-byte	read-only			
		69	bit4	E171 system 1 user-side freeze protection fault	double-byte	read-only			
		70	bit5	E271 system 2 user-side freeze protection fault	double-byte	read-only			
	2174	81	bit0	E19 level 1 freeze protection fault	double-byte	read-only			DIG11
		82	bit1	E29 level 2 freeze protection fault	double-byte	read-only			
		83	bit2	E065 water supply overtemperature protection fault	double-byte	read-only			
		84	bit3	E071 water supply undertemperature protection fault	double-byte	read-only			
85		bit4	TP low ambient temperature protection fault	double-byte	read-only				
86		bit5	E04 electric heating overload protection fault	double-byte	read-only				
87		bit6	E032 water flow switch protection fault	double-byte	read-only				
88		bit7	E06 water delta temperature protection fault	double-byte	read-only				
89		bit8	E103 fan 1 overtemperature protection fault	double-byte	read-only				
90		bit9	E203 fan 2 overtemperature protection fault	double-byte	read-only				
91		bit10	EE1 abnormal loss of power (reserved)	double-byte	read-only				
94		bit13	E081 DC fan board 1 communication fault	double-byte	read-only				
95		bit14	E082 DC fan board 1 communication fault	double-byte	read-only				
2175		97	bit0	P182 system 1 vapor supply overtemperature protection fault more than or equal to 3 occurrences	double-byte	read-only		DIG11	
	98	bit1	P282 system 2 vapor supply overtemperature protection fault more than or equal to 3 occurrences	double-byte	read-only				
	101	bit4	E11 system 1 overpressure protection fault more than or equal to 3 occurrences	double-byte	read-only				
	102	bit5	E21 system 2 overpressure protection fault more than or equal to 3 occurrences	double-byte	read-only				
	105	bit8	E12 system 1 underpressure protection fault more than or equal to 3 occurrences	double-byte	read-only				
	106	bit9	E22 system 2 underpressure protection fault more than or equal to 3 occurrences	double-byte	read-only				
	109	bit12	E171 system 1 user-side freeze protection more than or equal to 3 occurrences	double-byte	read-only				
	110	bit13	E271 system 2 user-side freeze protection more than or equal to 3 occurrences	double-byte	read-only				
	121	bit8	E065 water supply overtemperature protection fault more than 3 occurrences (0-not present/1-present)	double-byte	read-only				
	122	bit9	E071 water supply undertemperature protection fault more than 3 occurrences (0-not present/1-present)	double-byte	read-only				
	123	bit10	E04 electric heating overload protection fault more than 3 occurrences (0-not present/1-present)	double-byte	read-only				
	124	bit11	E032 water flow switch protection fault more than or equal to 3 occurrences	double-byte	read-only				
	125	bit12	E06 water delta temperature protection fault more than or equal to 3 occurrences	double-byte	read-only				
	126	bit13	E036 water level sensor fault	double-byte	read-only				
	127	bit14	P152 system 1 coil outlet temperature sensor fault	double-byte	read-only				
	128	bit15	P252 system 2 coil outlet temperature sensor fault	double-byte	read-only				

Controls and Operation

Address	Function	Display Parameter	Name	Byte length	Read/write	Options	Data Type
2177	129	bit0	E035 low water flow protection fault	double-byte	read-only		DIGI1
	130	bit1	PP12 system 1 high-side pressure sensor fault	double-byte	read-only		
	131	bit2	PP22 system 2 high-side pressure sensor fault	double-byte	read-only		
	132	bit3	E131 system 1 refrigerant leakage abnormality	double-byte	read-only		
	133	bit4	E231 system 2 refrigerant leakage abnormality	double-byte	read-only		
	134	bit5	E121 system 1 reversing valve abnormal operation	double-byte	read-only	(color display and integrated control 1 occurranne, DTU 3 occurrences)	
	135	bit6	E221 system 2 reversing valve abnormal operation	double-byte	read-only	(color display and integrated control 1 occurranne, DTU 3 occurrences)	
	136	bit7	E035 low water flow protection fault more than or equal to 3 occurrences	double-byte	read-only		
	137	bit8	E103 fan 1 overtemperature protection fault more than or equal to 3 occurrences	double-byte	read-only		
	138	bit9	E203 fan 2 overtemperature protection fault more than or equal to 3 occurrences	double-byte	read-only		
	139	bit10	E131 system 1 refrigerant leakage abnormality more than or equal to 3 occurrences	double-byte	read-only		
	140	bit11	E231 system 2 refrigerant leakage abnormality more than or equal to 3 occurrences	double-byte	read-only		
	141	bit12	E077 system 1 vapor return overtemperature protection fault	double-byte	read-only		
	142	bit13	E078 system 2 vapor return overtemperature protection fault	double-byte	read-only		
	143	bit14	E077 system 1 vapor return overtemperature protection fault more than or equal to 3 occurrences	double-byte	read-only		
144	bit15	E078 system 2 vapor return overtemperature protection fault more than or equal to 3 occurrences	double-byte	read-only			
2178	145	bit0	F151 system 1 compressor communication fault	double-byte	read-only		DIGI1
	146	bit1	F152 system 1 compressor failed to start	double-byte	read-only	(color display and integrated control 1 occurranne, DTU 3 occurrences)	
	147	bit2	F153 system 1 starting IPM protection fault	double-byte	read-only	(10 color display and integrated control 1 occurranne, DTU 3 occurrences)	
	148	bit3	F154 system 1 running IPM protection fault	double-byte	read-only	(10 color display and integrated control 1 occurranne, DTU 3 occurrences)	
	149	bit4	F156 system 1 compressor overcurrent protection fault	double-byte	read-only	(color display and integrated control 1 occurranne, DTU 3 occurrences)	
	150	bit5	F155 compressor 1 IPM overtemperature protection fault	double-byte	read-only	(10 color display and integrated control 1 occurranne, DTU 3 occurrences)	
	151	bit6	F157 compressor 1 bus overvoltage protection fault	double-byte	read-only	(10 color display and integrated control 1 occurranne, DTU 3 occurrences)	
	152	bit7	F158 compressor 1 bus undervoltage protection fault	double-byte	read-only	(10 color display and integrated control 1 occurranne, DTU 3 occurrences)	
	153	bit8	F251 system 2 compressor communication fault	double-byte	read-only		
	154	bit9	F252 system 2 compressor failed to start	double-byte	read-only	(color display and integrated control 1 occurranne, DTU 3 occurrences)	
	155	bit10	F253 system 2 starting IPM protection fault	double-byte	read-only	(10 color display and integrated control 1 occurranne, DTU 3 occurrences)	
	156	bit11	F254 system 2 running IPM protection fault	double-byte	read-only	(10 color display and integrated control 1 occurranne, DTU 3 occurrences)	
	157	bit12	F256 system 2 compressor overcurrent protection fault	double-byte	read-only	(color display and integrated control 1 occurranne, DTU 3 occurrences)	
	158	bit13	F255 compressor 2 IPM overtemperature protection fault	double-byte	read-only	(10 color display and integrated control 1 occurranne, DTU 3 occurrences)	
	159	bit14	F257 compressor 2 bus overvoltage protection fault	double-byte	read-only	(10 color display and integrated control 1 occurranne, DTU 3 occurrences)	
160	bit15	F258 compressor 2 bus undervoltage protection fault	double-byte	read-only	(10 color display and integrated control 1 occurranne, DTU 3 occurrences)		
2179	161	bit0	F101 fan 1 output loss-of-phase-power protection fault	double-byte	read-only	(color display and integrated control 1 occurranne, DTU 3 occurrences)	DIGI1
	162	bit1	F102 fan 1 output zero-speed protection fault	double-byte	read-only	(10 color display and integrated control 1 occurranne, DTU 3 occurrences)	
	163	bit2	F103 fan 1 starting IPM protection fault	double-byte	read-only	(10 color display and integrated control 1 occurranne, DTU 3 occurrences)	
	164	bit3	F104 fan 1 running IPM protection fault	double-byte	read-only	(color display and integrated control 1 occurranne, DTU 3 occurrences)	
	165	bit4	F105 fan 1 overcurrent protection fault	double-byte	read-only	(color display and integrated control 1 occurranne, DTU 3 occurrences)	
	166	bit5	F106 fan 1 overtemperature protection fault	double-byte	read-only	(10 color display and integrated control 1 occurranne, DTU 3 occurrences)	
	167	bit6	F107 fan 1 bus overvoltage protection fault	double-byte	read-only	(10 color display and integrated control 1 occurranne, DTU 3 occurrences)	
	168	bit7	F108 fan 1 bus undervoltage protection fault	double-byte	read-only	(10 color display and integrated control 1 occurranne, DTU 3 occurrences)	
	169	bit8	F201 fan 2 output loss-of-phase-power protection fault	double-byte	read-only	(color display and integrated control 1 occurranne, DTU 3 occurrences)	
	170	bit9	F202 fan 2 output zero-speed protection fault	double-byte	read-only	(10 color display and integrated control 1 occurranne, DTU 3 occurrences)	
	171	bit10	F203 fan 2 starting IPM protection fault	double-byte	read-only	(10 color display and integrated control 1 occurranne, DTU 3 occurrences)	
	172	bit11	F204 fan 2 running IPM protection fault	double-byte	read-only	(color display and integrated control 1 occurranne, DTU 3 occurrences)	
	173	bit12	F205 fan 2 overcurrent protection fault	double-byte	read-only	(color display and integrated control 1 occurranne, DTU 3 occurrences)	
	174	bit13	F206 fan 2 overtemperature protection fault	double-byte	read-only	(10 color display and integrated control 1 occurranne, DTU 3 occurrences)	
	175	bit14	F207 fan 2 bus overvoltage protection fault	double-byte	read-only	(10 color display and integrated control 1 occurranne, DTU 3 occurrences)	
	176	bit15	F208 fan 2 bus undervoltage protection fault	double-byte	read-only	(10 color display and integrated control 1 occurranne, DTU 3 occurrences)	

Controls and Operation

Address	Function	Display Parameter	Name	Byte length	Read/write	Options	Data Type
3011	03/16		color display line controller status flag	double-byte	read/write	bit0 : reserved bit10 : changes occurred in address 1001-1090 (0-false/1-true) bit20 : changes occurred in address 1091-1180 (0-false/1-true) bit30 : changes occurred in address 1181-1270 (0-false/1-true) bit150 : color display is powered-on for the first time (0-false/1-true)/ongoing download or upload (0-false/1-true)	DIG11
3017	03/16		current year	double-byte	read-only	data on the communication being 1, represents 2001; data on the communication being 15, represents 2015	DIG11
3018	03/16		current month	double-byte	read-only	data on the communication being 1, represents January; data on the communication being 10, represents October	DIG11
3019	03/16		current day of month	double-byte	read-only	data on the communication being 1, represents the first day of the month; data on the communication being 10, represents the 10th day of the month	DIG11
3020	03/16		current hour	double-byte	read-only	data on the communication being 1, represents 1, data on the communication being 10, represents 10	DIG11
3021	03/16		current minute	double-byte	read-only	data on the communication being 1, represents 1, data on the communication being 10, represents 10	DIG11

Controls and Operation

Table 11 Error Codes and Troubleshooting

Protection/failure	Codes	Causes	Possible fixes
Communication Fault	E08	Abnormal communication between wire controller and the main board	Inspect whether the wire controller, the main board and the connection thereof are reliable
The Wire Controller Does Not Match The Mainboard	E084		
DC Fan Board 1 Communication Fault	E081	Communication of the speed regulation module 1 with main board is abnormal	"Check the speed regulation module 1 and the main board and if their connections are normal and reliable."
Syst1: High Pressure Prot.	E11	The high-voltage switch of the system is disconnected	Inspect System 1 voltage switch and refrigerating circuit for any failure
Syst2: High Pressure Prot.	E21	The high-voltage switch of the system is disconnected	Inspect System 2 voltage switch and refrigerating circuit for any failure
Syst1: Low Pressure Prot.	E12	The low-voltage switch of the system is disconnected	Inspect System 1 voltage switch and refrigerating circuit for any failure
Syst2: Low Pressure Prot.	E22	The low-voltage switch of the system is disconnected	Inspect System 2 voltage switch and refrigerating circuit for any failure
Water Flow Switch Prot.	E032	The water system has no or only few water	Inspect whether the water flow of the water pipe conforms to related requirements and check the water pump for any damages
Electric Heater Overload Prot.	E04	Electric heating overheat protection switch is disconnected	Inspect whether the electric heating is under operation condition of over 150 C for a long time
Primary Antifreezing Prot. In Winter	E19	Excessively low environment temperature	
Secondary Antifreezing Prot. in Winter	E29	Excessively low environment temperature	
Syst1: User Side Antifreezing Prot.	E171	The water flow of the system is insufficient	Inspect whether the water flow of the water pipe conforms to related requirements and check the water pump for any blockage
Syst2: User Side Antifreezing Prot.	E271	The water flow of the system is insufficient	Inspect whether the water flow of the water pipe conforms to related requirements and check the water pump for any blockage
Water(Out) High Temp Prot.	E065	Excessively high water outlet temperature	
Fan 1 Thermal Overload Prot.	E103	Fan 1 thermal overload	Check if fan 1 is running normally
Fan 2 Thermal Overload Prot.	E203	Fan 2 thermal overload	Check if fan 2 is running normally
Syst1: Exhaust Air High Temp Prot.	P182	The system compressor is overloaded	Inspect whether the operation of System 1 compressor is normal
Syst2: Exhaust Air High Temp Prot.	P282	The system compressor is overloaded	Inspect whether the operation of System 2 compressor is normal
Water In/Out Large Temp Diff Prot.	E06	The water flow of the system is insufficient, the pressure difference of the water system is small	Inspect whether the water flow of the water pipe conforms to related requirements and check the water pump for any blockage
Water(Out) Low Temp Prot.	E071	Excessively low water outlet temperature	
Low Water Flow Prot.	E035	The system has no water or too low volume of water	Check if the water flow of water pipe meets the requirements and if the water pump is damaged.
Syst1:Refrigerant Leakage Abnormal	E131	System 1 refrigerant leakage	Check if the refrigerant in the system leaks
Syst2: Refrigerant Leakage Abnormal	E231	System 2 refrigerant leakage	Check if the refrigerant in the system leaks
Syst1: 4-Way Valve Abnormal Switch	E121	SYS1 four-way valve switching failed	Check if the four-way valve commutation state is the desired state
Syst2: 4-Way Valve Abnormal Switch	E221	SYS2 four-way valve switching failed	Check if the four-way valve commutation state is the desired state
Syst1: Low Pressure Prot. 3+	E12	The low-voltage switch of the system is disconnected	Inspect System 1 voltage switch and refrigerating circuit for any failure
Syst2: Low Pressure Prot. 3+	E22	The low-voltage switch of the system is disconnected	Inspect System 2 voltage switch and refrigerating circuit for any failure

Controls and Operation

Table 11 Error Codes and Troubleshooting

Protection/fault	Codes	Causes	Possible fixes
Water Flow Switch Prot. 3+	E032	The water system has no or only few water	Inspect whether the water flow of the water pipe conforms to related requirements and check the water pump for any damages
Electric Heater Overload Prot. 3+	E04	Electric heating overheat protection switch is disconnected	Inspect whether the electric heating is under operation condition of over 150 C for a long time
Syst1: User Side Antifreezing Prot. 3+	E171	The water flow of the system is insufficient	Inspect whether the water flow of the water pipe conforms to related requirements and check the water pump for any blockage
Syst2: User Side Antifreezing Prot. 3+	E271	The water flow of the system is insufficient	Inspect whether the water flow of the water pipe conforms to related requirements and check the water pump for any blockage
Water(Out) High Temp Prot. 3+	E065	Excessively high water outlet temperature	
Low Water Flow Prot. 3+	E035	The system has no water or too low volume of water	Check if the water flow of water pipe meets the requirements and if the water pump is damaged.
Syst1: Exhaust Air High Temp Prot. 3+	P182	The system compressor is overloaded	Inspect whether the operation of System 1 compressor is normal
Syst2: Exhaust Air High Temp Prot. 3+	P282	The system compressor is overloaded	Inspect whether the operation of System 2 compressor is normal
Water In/Out Large Temp Diff Prot. 3+	E06	The water flow of the system is insufficient, the pressure difference of the water system is small	Inspect whether the water flow of the water pipe conforms to related requirements and check the water pump for any blockage
Water(Out) Low Temp Prot. 3+	E071	Excessively low water outlet temperature	
Water In Sensor Fault	P01	The temperature sensor is open or short circuited	Check and replace inlet water temperature sensor
Water Out Sensor Fault	P02	The temperature sensor is open or short circuited	Check and replace outlet water temperature sensor
Syst1: Coil Temp Sensor1 Fault	P150	The temperature sensor is open or short circuited	Check and replace the system 1 coil 1 temperature sensor
AT Sensor Fault	P04	The temperature sensor is open or short circuited	Check and replace the ambient temperature sensor
Syst1: Suction Temp Sensor Fault	P17	The temperature sensor is open or short circuited	Check and replace the system 1 return air temperature sensor
Syst1: User Side Antifreezing 1 Sensor Fault	P191	The temperature sensor is open or short circuited	Check and replace the system 1 use side antifreeze 1 temperature sensor
Syst2:Coil Temp Sensor1 Fault	P250	The temperature sensor is open or short circuited	Check and replace the system 2 coil 1 temperature sensor
Syst1: Coil(Out) Temp Sensor Fault	P152	The temperature sensor is open or short circuited	Check and replace the system 1 coil outlet temperature sensor
Syst2: Coil(Out) Temp Sensor Fault	P252	The temperature sensor is open or short circuited	Check and replace the system 2 coil outlet temperature sensor
Syst1: EVI(In) Temp Sensor Fault	P101	The temperature sensor is open or short circuited	Check and replace the system 1 EVI inlet temperature sensor
Syst1: EVI(Out) Temp Sensor Fault	P102	The temperature sensor is open or short circuited	Check and replace the system 1 EVI outlet temperature sensor
Syst1: Exhaust Air Temp Sensor Fault	P181	The temperature sensor is open or short circuited	Check and replace the system 1 exhaust temperature sensor
Water Level Sensor Fault	E036	Open circuit or short circuit of the water level sensor	Inspect and replace water level sensor
Syst1: Low Pressure Sensor Fault	PP11	The sensor is open or short circuited	Check and replace the system 1 low pressure sensor
Syst2: Suction Temp Sensor Fault	P27	The temperature sensor is open or short circuited	Check and replace the system 2 return air temperature sensor
Syst2: User Side Antifreezing 1 Sensor Fault	P291	Temperature sensor fault	Check if the temperature sensor is working properly
Syst1: High Pressure Sensor Fault	PP12	The sensor is open or short circuited	Check and replace the system 1 high pressure sensor
Syst2: High Pressure Sensor Fault	PP22	The sensor is open or short circuited	Check and replace the system 2 high pressure sensor

Controls and Operation

Table 11 Error Codes and Troubleshooting

Protection/fault	Codes	Causes	Possible fixes
Syst2: Exhaust Air Temp Sensor Fault	P281	Open circuit or short circuit of the temperature sensor	Inspect and replace System 2 exhaust temperature sensor
Syst2: Low Pressure Sensor Fault	PP21	Open circuit or short circuit of the sensor	Inspect and replace System 2 low-voltage sensor
Water Tank Temp Fault	P03	Open circuit or short circuit of the temperature sensor	Inspect and replace water tank temperature sensor
Syst2: EVI(In) Temp Sensor Fault	P201	Open circuit or short circuit of the temperature sensor	Inspect and replace System 2 enthalpy inlet temperature sensor
Syst2: EVI(Out) Temp Sensor Fault	P202	Open circuit or short circuit of the temperature sensor	Inspect and replace System 2 enthalpy outlet temperature sensor
Low AT Power-Off Prot.	TP	Excessively low environment temperature	
Syst1: Coil Temp Sensor2 Fault	P154	The temperature sensor is open or short circuited	Check and replace the system 1 coil 2 temperature sensor
DC Fan Board 2 Communication Fault	E082	Communication of the speed regulation module 2 with main board is abnormal	Check the speed regulation module 2 and the main board and if their connections are normal and reliable.
Syst2: Coil Temp Sensor2 Fault	P254	The temperature sensor is open or short circuited	Check and replace the system 2 coil 2 temperature sensor
Syst1: Comp. Communication Fault	F151	Communication failure with system 1 compressor drive board	1. Check if the communication line is normal; 2. Check if the system 1 compressor drive board is normal
Syst1: Comp. Start Fault	F152	System 1 compressor failed to start	1. Check if the compressor line is normal; 2. Check if the system 1 compressor is blocked
Syst1: Start IPM Prot.	F153	System 1 compressor starting current is too large	1. Check if the starting high pressure is excessive; 2. Check if the system 1 compressor is blocked
Syst1: Running IPM Prot.	F154	System 1 compressor running current is too large	Check if the pressure ratio is too high
Syst1: Comp. Overcurrent Prot.	F156	System 1 compressor running current is too large	Check if the pressure ratio is too high
Comp. 1 IPM Over-Temp. Prot.	F155	System 1 compressor drive board has poor heat dissipation	Check if there is a gap in the installation of the fluorine-cooled heat sink
Press 1 Bus Over Voltage Prot.	F157	Voltage is too high	Check if the input voltage is higher than 480V
Press 1 Bus Under Voltage Prot.	F158	Voltage is too low	Check if the input voltage is lower than 250V
Syst2: Comp. Communication Fault	F251	Communication failure with system 2 compressor drive board	1. Check if the communication line is normal; 2. Check if the system 2 compressor drive board is normal
Syst2: Comp. Start Fault	F252	System 2 compressor failed to start	1. Check if the compressor line is normal; 2. Check if the system 2 compressor rotor is locked
Syst2: Start IPM Prot.	F253	System 2 compressor starting current is too large	1. Check if the starting high pressure is excessive; 2. Check if the system 1 compressor is blocked
Syst2: Running IPM Prot.	F254	System 2 compressor running current is too large	Check if the pressure ratio is too high
Syst2: Comp. Overcurrent Prot.	F256	System 2 compressor running current is too large	Check if the pressure ratio is too high
Press 2 IPM Over-Temp Prot.	F255	System 2 compressor drive board has poor heat dissipation	Check if there is a gap in the installation of the fluorine-cooled heat sink
Press 2 Bus Over Voltage Prot.	F257	Voltage is too high	Check if the input voltage is higher than 480V
Press 2 Bus Under Voltage Prot.	F258	Voltage is too low	Check if the input voltage is lower than 250V
Fan 1 Phase Loss Prot.	F101	System 1 fan failed to start	Check if the system 1 fan line is normal
Fan 1 Zero Speed Prot.	F102	System 1 fan failed to start	Check if the system 1 fan rotor is locked
Fan 1 Start IPM Prot.	F103	System 1 fan starting current is too large	Check if the system 1 fan rotor is locked

Controls and Operation

Table 11 Error Codes and Troubleshooting

Protection/fault	Codes	Causes	Possible fixes
Fan 1 Running IPM Prot.	F104	System 1 fan running current is too large	Check if the system 1 fan rotor is locked
Fan 1 Overcurrent Prot.	F105	System 1 fan running current is too large	Check if the system 1 fan rotor is locked
Fan 1 Over-Temp Prot.	F106	System 1 fan drive board has poor heat dissipation	Check the heat dissipation condition
Fan 1 Bus Over Voltage Prot.	F107	Voltage is too high	Check if the input voltage is higher than 480V
Fan 1 Bus Under Voltage Prot.	F108	Voltage is too low	Check if the input voltage is lower than 250V
Fan 2 Output Phase Loss Prot.	F201	System 2 fan failed to start	Check if the system 2 fan line is normal
Fan 2 Output Zero Speed Prot.	F202	System 2 fan failed to start	Check if the system 2 fan rotor is locked
Fan 2 Start IPM Prot.	F203	System 2 fan starting current is too large	Check if the system 2 fan rotor is locked
Fan 2 Running IPM Prot.	F204	System 2 fan running current is too large	Check if the system 2 fan rotor is locked
Fan 2 Overcurrent Prot.	F205	System 2 fan running current is too large	Check if the system 2 fan rotor is locked
Fan 2 Over-Temp Prot.	F206	System 2 fan drive board has poor heat dissipation	Check the heat dissipation condition
Fan 2 Bus Over Voltage Prot.	F207	Voltage is too high	Check if the input voltage is higher than 480V
Fan 2 Bus Under Voltage Prot.	F208	Voltage is too low	Check if the input voltage is lower than 250V
Abnormal Power Fault	EE1		
Syst1: High Suction Temp Prot.	E077	SYS1 return air temperature is too high	Check if the return air temperature sensor is normal
Syst2: High Suction Temp Prot.	E078	SYS2 return air temperature is too high	Check if the return air temperature value is greater than the protection value
Syst1: High Suction Temp Prot. 3+	E077	SYS1 return air temperature is too high	Check if the return air temperature sensor is normal
Syst2: High Suction Temp Prot. 3+	E078	SYS2 return air temperature is too high	Check if the return air temperature value is greater than the protection value



HP Series Limited Warranty

The “Manufacturer” warrants to the original owner at the original installation site that the compressor of the Industrial, Commercial, and other Non-Residential Use Air-to-Water Heat Pump (the “Product”) will be free from defects in material or workmanship for five (5) years from the date of installation. If upon examination by the Manufacturer the Product is shown to have a defect in material or workmanship during the warranty period, the Manufacturer will repair or replace, at its option, that part of the Product which is shown to be defective. All other Mestek supplied Air-to-Water Heat Pump parts are warranted against defects in material and workmanship for two (2) years from date of installation or 18 months from date of shipment from Mestek. This Air-to-Water Heat Pump is designed to operate in a closed loop heating system. System fill water must not contain more than 500 ppm Total Dissolved Solids and a minimum 80 ppm - maximum 200 ppm Water Hardness. Suspended solids such as Magnetite, Iron Oxides must be flushed from the system prior to commissioning the Air-to-Water Heat Pump(s). The PH level must be within the 6.5-8.5 range. Where required, the system must be protected by the addition of a corrosion inhibitor per the chemical supplier’s instructions.

This limited warranty does not apply:

- (a) If the Product has been subjected to misuse or neglect, has been accidentally or intentionally damaged, has not been installed, maintained or operated in accordance with the furnished written instructions, or has been altered or modified in any way.

These include but not limited to:

- Chemical corrosion, no corrosive chemical (dry cleaning chemicals, degreasing liquids, chlorine or any chemicals that produce hydrochloric acid) can be present around the Air-to-Water Heat Pump as it rapidly destroys the equipment and voids the warranty.
- (b) to any expenses, including labor or material, incurred during removal or reinstallation of the Product or parts thereof.
- (c) to damage as a result of settlement, distortion, collapse, or cracking of any foundation area, beams or pipes surrounding the Product.
- (d) to any workmanship of any installer of the Product; or to Products installed outside the continental United States or Canada.

This limited warranty is conditional upon:

- (a) shipment, to the Manufacturer, of that part of the Product thought to be defective. Goods can only be returned with prior written approval from the Manufacturer. All returns must be freight prepaid.
- (b) determination in the reasonable opinion of the Manufacturer that there exists a defect in material or workmanship. Repair or replacement of any part under this Limited Warranty shall not extend the duration of the warranty with respect to such repaired or replaced part beyond the stated warranty period. **THIS LIMITED WARRANTY IS IN LIEU OF ALL OTHER WARRANTIES, EITHER EXPRESS OR IMPLIED, AND ALL SUCH OTHER WARRANTIES, INCLUDING WITHOUT LIMITATION IMPLIED WARRANTIES OF MERCHANTABILITY OR FITNESS FOR A PARTICULAR PURPOSE, ARE HEREBY DISCLAIMED AND EXCLUDED FROM THIS LIMITED WARRANTY. IN NO EVENT SHALL THE MANUFACTURER BE LIABLE IN ANY WAY FOR ANY CONSEQUENTIAL, SPECIAL, OR INCIDENTAL DAMAGES OF ANY NATURE WHATSOEVER, OR FOR ANY AMOUNTS IN EXCESS OF THE SELLING PRICE OF THE PRODUCT OR ANY PARTS THEREOF FOUND TO BE DEFECTIVE. THIS LIMITED WARRANTY GIVES THE ORIGINAL OWNER OF THE PRODUCT SPECIFIC LEGAL RIGHTS. YOU MAY ALSO HAVE OTHER RIGHTS WHICH MAY VARY BY EACH JURISDICTION.**





MESTEK, INC.

260 North Elm Street
Westfield, MA 01085
Phone: (413) 564-5540

7555 Tranmere Drive
Mississauga, Ontario L5S 1L4 Canada
Phone: (905) 670-5888

www.mestek.com